



UNITED NATIONS ECONOMIC COMMISSION FOR EUROPE

UNITED NATIONS CENTRE FOR TRADE FACILITATION
AND ELECTRONIC BUSINESS (UN/CEFACT)

**REQUIREMENTS SPECIFICATION MAPPING
(RSM)**

CCBDA Cross Industry Ordering Process v3.0

Approved: UN/CEFACT Bureau _____

Public Review

Version: 3.0

Release: 1

1
2
3
4
5
6
7
8
9
10
11
12
13
14
15
16
17
18
19
20
21
22
23
24
25
26
27
28
29
30
31
32
33
34
35
36
37
38
39
40

41

42 **Contributors**

Name	Organization
Mary Kay Blantz	
Karina Duvinger	
Gerhard Heemskerk (Lead Editor)	
Colin Laughlan	
Andreas Pelekies	
Sue Probert	
Hisanao Sugamata	
Lance Thompson	
Ian Watt	
Rolf Wessel	

43

44

Public Review

TABLE OF CONTENTS

45		
46	2	INTRODUCTION..... 5
47	2.1	AUDIENCE.....5
48	2.2	REFERENCE DOCUMENTS.....5
49	3	DOCUMENT HISTORY 6
50	3.1	PURPOSE AND SCOPE.....6
51	3.2	TARGET SOLUTION6
52	4	BUSINESS REQUIREMENTS SUMMARY 7
53	4.1	BUSINESS PROCESSES, INFORMATION ENVELOPES AND AUTHORISED ROLES.....7
54	4.2	BUSINESS PARTNER TYPES AND AUTHORISED ROLES7
55	5	CONCEPTUAL MODEL 8
56	7	INFORMATION MAPPING 9
57	7.1	REFERENCED CCL.....9
58	7.2	BUSINESS INFORMATION ENTITY MODEL9
59	7.3	NEW AND CHANGED COMPONENTS.....16
60	7.4	DETAILED CLASS DIAGRAMS.....16
61	7.6	CORE COMPONENTS MODEL EXTRACT26
62	7.7	LOGICAL MESSAGE STRUCTURE.....26
63	7.7.1	<i>Message Assembly</i>26
64	8	BUSINESS INFORMATION ENTITIES USED28
65	9	CODE LISTS USED.....95
66	9.1	NEW CODE LIST.....95
67	9.2	ADDITIONS TO AN EXISTING CODE LIST.....95
68	9.3	USE OR REFERENCE OF AN EXISTING CODE LIST.....95
69	9.4	RESTRICTION OF AN EXISTING CODE LIST.....96
70	10	MESSAGE LIBRARY UPDATE.....97
71	10.1	MESSAGE ASSEMBLY SUBMISSION.....97
72	10.2	CORE COMPONENT LIBRARY UPDATE97
73	10.2.1	<i>Referenced CCL</i>97
74	10.2.2	<i>CCL Update Submission</i>97
75	10.3	MODEL EXCHANGE FILE.....97
76	10.4	ADDITIONAL INFORMATION.....97
77	12	DEFINITION OF TERMS98
78		
79	Table 1	Document history.....6
80	Table 2	Change log.....6
81	Table 3	Business Partner Types and Authorized Roles7
82	Table 4	Order Message Assembly Realization Table.....26
83	Table 5	Order Change Message Assembly Realization Table.....27
84	Table 6	Order Response Message Assembly Realization Table.....27
85	Table 7	BIEs used in Order Messages29
86	Table 8	Use or Reference of an Existing Code List.....95
87		
88	Figure 1	Cross Industry Order conceptual data model8
89	Figure 2	Exchanged Document, Exchanged Document Context and Document Line Document9
90	Figure 3	Header Trade Agreement.....10
91	Figure 4	Header Trade Delivery11
92	Figure 5	Header Trade Settlement12
93	Figure 6	Line Trade Agreement.....13
94	Figure 7	Line Trade Delivery14
95	Figure 8	Line Trade Settlement15
96	Figure 9	Trade Product16
97	Figure 10	Cross Industry Order (root elements)17

98 Figure 11 Trade Transaction 18
99 Figure 12 Header Trade Agreement..... 19
100 Figure 13 Header Trade Delivery 20
101 Figure 14 Header Trade Settlement 21
102 Figure 15 Trade Line Item 22
103 Figure 16 Line Trade Agreement..... 23
104 Figure 17 Line Trade Delivery..... 24
105 Figure 18 Line Trade Settlement 25
106
107

Public Review

108 2 Introduction

109 The current practice of the exchange of business documents by means of telecommunications – usually
110 defined as e-Business presents a major opportunity to improve the competitiveness of companies,
111 especially for Small and Medium Enterprises (SME).

112 The ordering process is used to agree on delivery and payment of goods or services between the
113 supplier and the customer.

114 Started as an initiative by CEN/ISSS Work shop eBES, the European Expert Group 1 (EEG1) – Supply
115 Chain & e-Procurement developed the first draft of Cross Industry Order. The Cross Industry Order has
116 been compiled using the EUROFER ESIDEL version 1.0 as the base, with contributions and
117 submissions from: EUROFER, GS1, CIDX, EDIFICE, AIAG/ODETTE/JAMA, GHX and EDS.

118 The structure of this document is based on the structure of the UN/CEFACT Requirements Specification
119 Mapping (RSM) – Documentation Template and Conformity Rules, document reference
120 CEFACT/ICG/006.

121 Version 1.00.09 of the BRS was taken as the basis to develop the CCBDA Requirements Specification
122 Mapping (RSM) version 1. The structure of this document is based on the structure of the UN/CEFACT
123 Requirements Specification Mapping (RSM) – Documentation Template Guidelines.

124 2.1 Audience

126 The main audiences for this document are the potential authors of individual RSMs. These
127 are primarily the UN/CEFACT business and IT experts who are responsible for specifying
128 the business requirements for e-business solutions in a specific domain and for furthering
129 the development of solutions as relevant standards. Authors may include other standards
130 bodies or users and developers in developed or developing economies.

132 2.2 Reference Documents

133 Knowledge and application of the following standards is crucial to the development of quality
134 business requirements specifications. Other key references are shown in the appropriate part of
135 the document.

- 137 - UN/CEFACT. Techniques and Methodologies Group (TMG). UN/CEFACT's Modelling
138 Methodology (UMM): UMM Meta Model Core Module. (Candidate for 2.0). 2009-01-30.

140 Formal definitions of many of the technical terms used in this RSM guideline may be found in
141 the above references but for convenience some key definitions are included in Annex 1 of
142 this document.

- 144 - UN/CEFACT Core Components Technical Specification – Part 8 of the ebXML Framework dated
145 15 November 2003 Version 2.01 - (CCTS 2.01)
- 146 - UN/CEFACT – Core Component Technical Specification *Technical Corrigendum* Version 2.01
147 (Corr. 1) dated 12 February 2007 (CCTS 2.01 Corr.1)
- 148 - UN/CEFACT Core Components Data Type Catalogue Version 2.1 dated 2008-04-08 (CCDTC
149 2.1)
- 150 - UN/CEFACT XML Naming and Design Rules Version 2.0, dated 17 February 2006 (NDR 2)
- 151 - UN/CEFACT UML Profile for Core Components (UPCC), Version 1.0, Final Specification, 2008-
152 01-16
- 153 - UN/CEFACT Core Components Business Document Assembly Technical Specification
154 (CCBDA) version 1.0
- 155 - UN/CEFACT Business Requirement Specification Cross Industry Ordering Process Version
156 1.00.09.
- 157 - UN/CEFACT Business Requirement Specification Supply Chain Reference Data Model
158 (SCRDM) Version 1.0.0.2.
- 159 - UN/CEFACT Requirement Mapping Specification Supply Chain Reference Data Model
160 (SCRDM) Version 1.0.0.2.

163 In this document the set of CCTS 2.01 / CCTS 2.01 Corr.1 / NDR 2 / CCDTC 2.1 specifications are
164 referred to as "UN/CEFACT Technical Specifications Version 2"..

165

166 3 Document History

167

168 **Table 1 Document history**

169

Phase	Status	Date Last Modified
ODP 3	Draft Development	15-06-2017
ODP 4	Public Review	17-07-2017
ODP 5	Publication	

170

171 **Table 2 Change log**

172

Date of Change	Version	Paragraph Changed	Summary of Changes	Author
01-2011	2.06		Initial CIO (Cross Industry Order) – document-driven	UN/CEFACT – TBG1
15-06-2017	3.0		Concept SCRDM CCBDA CIO (Cross Industry Order)	Gerhard Heemskerck (Lead Editor)

173

174 3.1 Purpose and Scope

175

176

177

178

179

180

181

182

183

184

185

186

187

188

189

190

3.2 Target Solution

The target solution is an implementation using XML schema based on the following UN/CEFACT specifications: CCTS 2.01, NDR 2.1, CCBDA 1.0 and the UN/CEFACT standard Supply Chain Reference Data Model.

191 4 Business Requirements Summary

192 In conjunction with the BRS document (UN/CEFACT Business Requirement Specification Cross
193 Industry Ordering Process Version 1.00.09), the purpose of this document is to provide a standard
194 framework for the exchange of information.

195 4.1 Business Processes, Information Envelopes and Authorised Roles

196 The BRS Cross Industry Ordering Process defines the following processes:

- 197 • The Customer sending an Order message to the Supplier
- 198 • The Supplier may accept or teject the Order or propose changes to the conditions of the order
199 using the Order Response message.
- 200 • The Customer may accept or reject the proposal or make a counter proposal using the Order
201 Change message.

202 4.2 Business Partner Types and Authorised Roles

- 203 - Buyer
- 204 - Seller

205 **Table 3 Business Partner Types and Authorized Roles**

206 Authorised Role Name	207 Business Partner Type Name
208 Order Sender	Buyer
Order Receiver	Seller
Order Response Sender	Seller
Order Response Receiver	Buyer
Order Change Proposer	Buyer
Order Change Responder	Seller

210

211 5 Conceptual Model

212 The conceptual model identifies the main Entity Classes. The following model is shown in the form
213 of class diagram.

214 **Figure 1 Cross Industry Order conceptual data model**

215

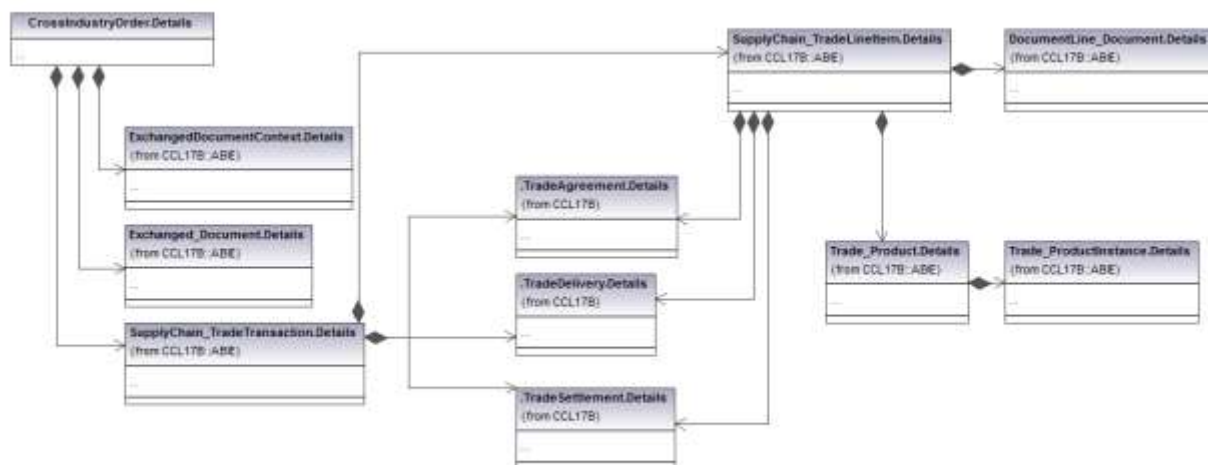

216

217

Philosophy behind the conceptual design

218

219 The conceptual design is based on the assumption that information exchanged in the order-
220 to-pay process tends to have a large degree of similarity. Therefore rather than linking the
221 information to message specific entities three neutral entities have been defined: Trade
222 Agreement, Trade Delivery and Trade Settlement. These entities contain the main semantic
payload for all communication exchanges, on header as well as on line level.

223

224 A fourth essential entity is the Product entity. This entity holds all characteristics of the trade
product that are independent of a particular trade transaction.

225

226 The Trade Transaction and Trade Line Item entities serve to structure the entities mentioned
before.

227

Description of the main entities

228

- Document Context: Application processing information for the business document.
- Document Heading: Generic document heading information such as Order number, Issue date.
- Trade Transaction: Information on the trade transaction(s) to which the order applies.
- Trade Line Item: Information on the line items that are being ordered.
- Trade Agreement: information on the commercial agreement on which the ordered trade transaction or line is based.
- Trade Delivery: information on the fulfillment of the order trade transaction or line.
- Trade Settlement: information on the financial settlement of the order trade transaction or line.
- Product: Information on the generic object that is being ordered.
- Product Instance: Information on the individual objects that are being ordered.

230

231

232

233

234

235

236

237

238

239

240

241 **7 Information Mapping**

242 **7.1 Referenced CCL**

243 CCL17B

244 **Remark:** Additions or changes to this CCL are included later in this section. During the harmonization
 245 process the change requests will be considered against the whole CCL and may lead to suggestions
 246 for the re-use or modification of existing core components.

247 **7.2 Business Information Entity Model**

248 For readability reasons the canonical model is provided in multiple diagrams, each providing a full
 249 description of a segment in the Cross Industry Order, Order Change and Order Response. The three
 250 entities Trade Agreement, Trade Delivery and Trade Settlement support the entire Order-to-Pay
 251 process. In the individual steps of the process, such as the Order, further refinements can be made
 252 on what is communicated on header and line level. Therefore in the canonical model for the Order
 253 message the Trade Agreement entity is realized as two supply chain entities, one for the header and
 254 one for the line.

255 **Figure 2 Exchanged Document, Exchanged Document Context and Document Line Document**

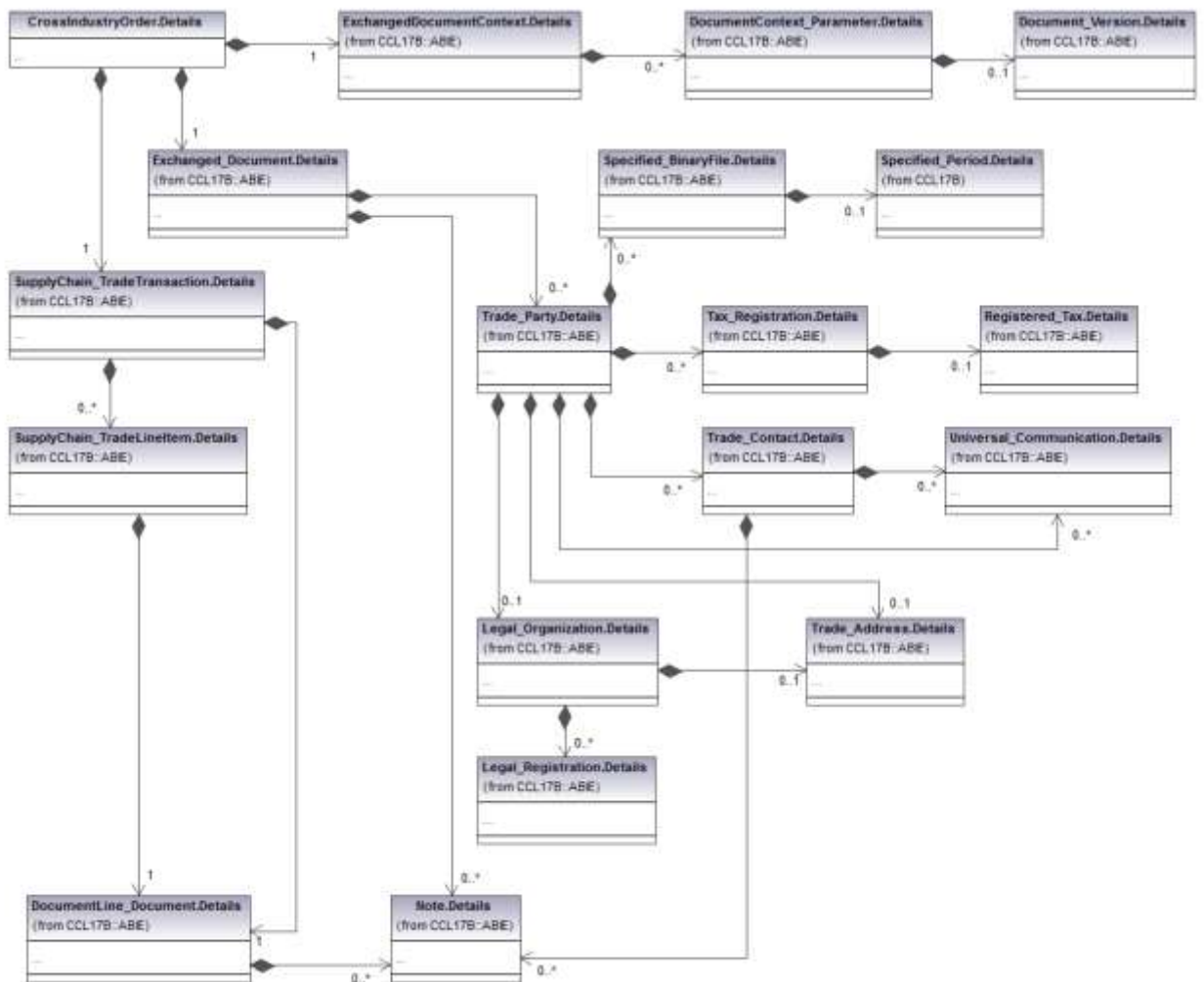

258
 259

260 **Figure 3 Header Trade Agreement**
 261

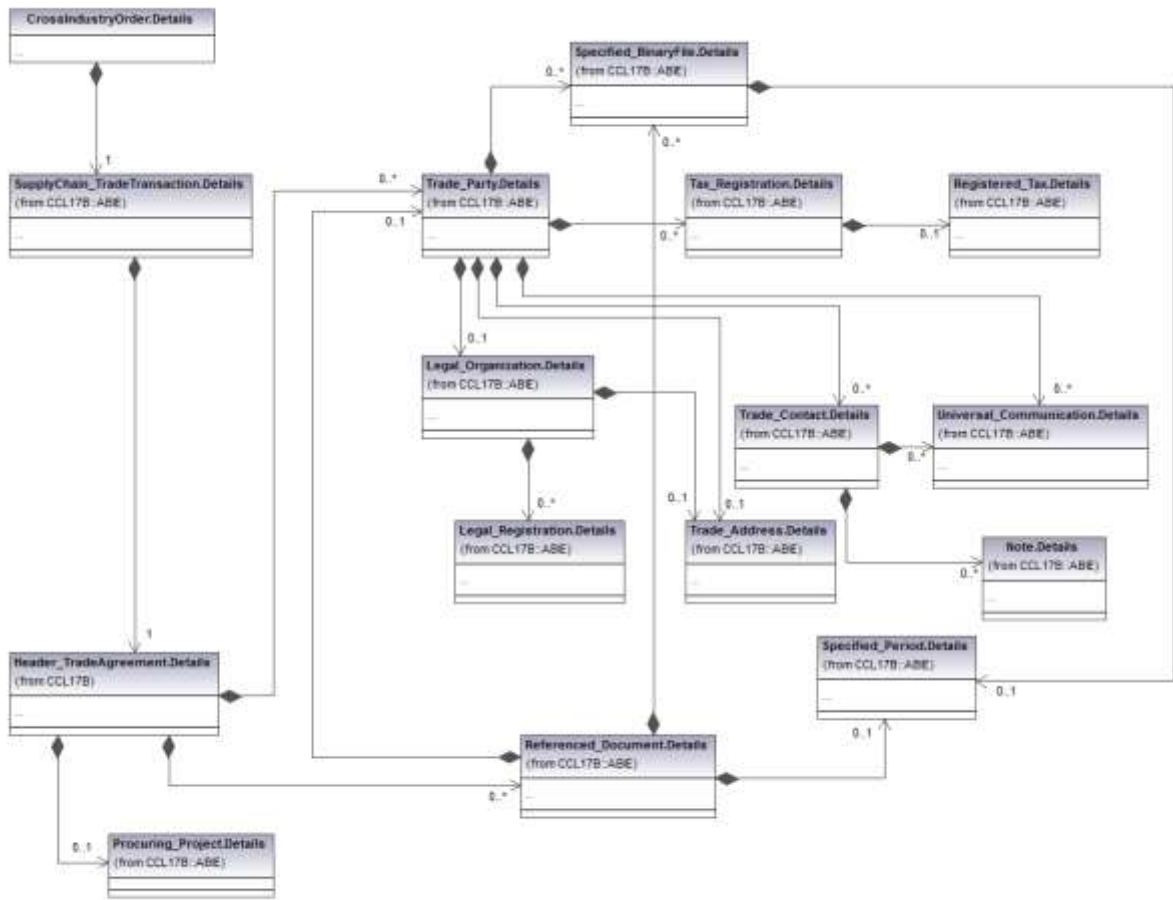

262
 263
 264
 265
 266
 267
 268

Public

269 **Figure 4 Header Trade Delivery**

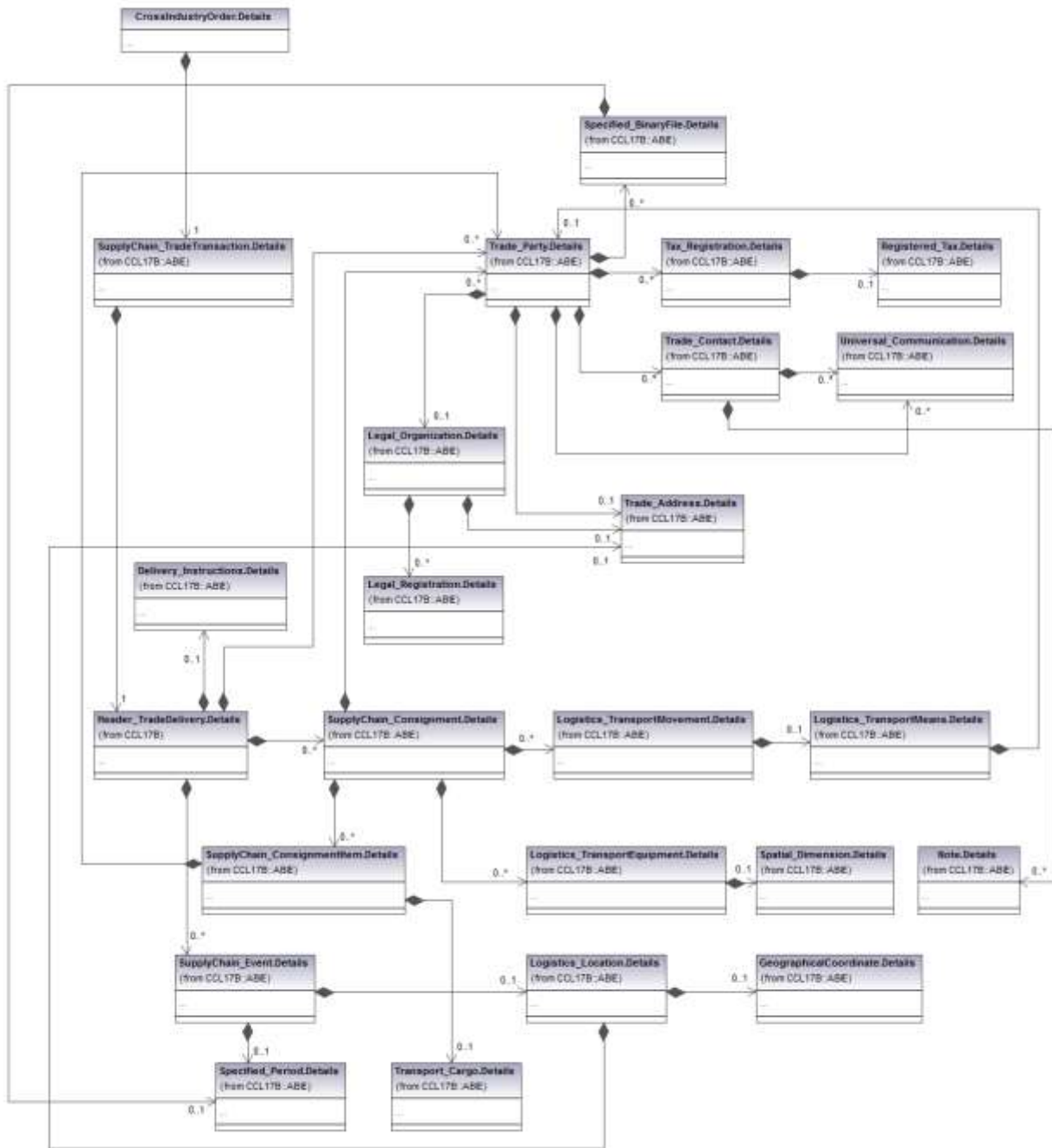

270
 271
 272
 273
 274
 275
 276
 277
 278

279 **Figure 5 Header Trade Settlement**

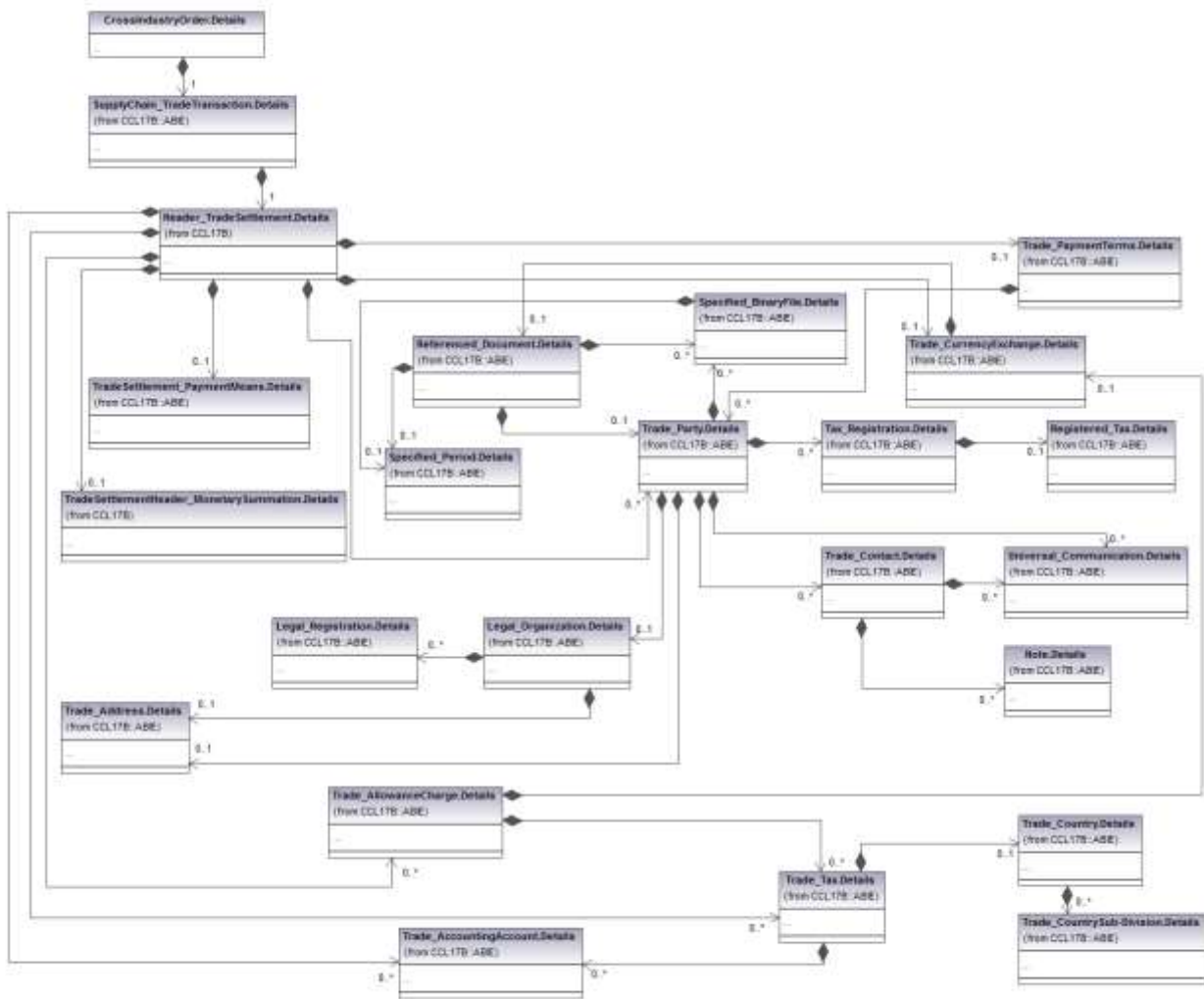

280
281

282 **Figure 6 Line Trade Agreement**
 283

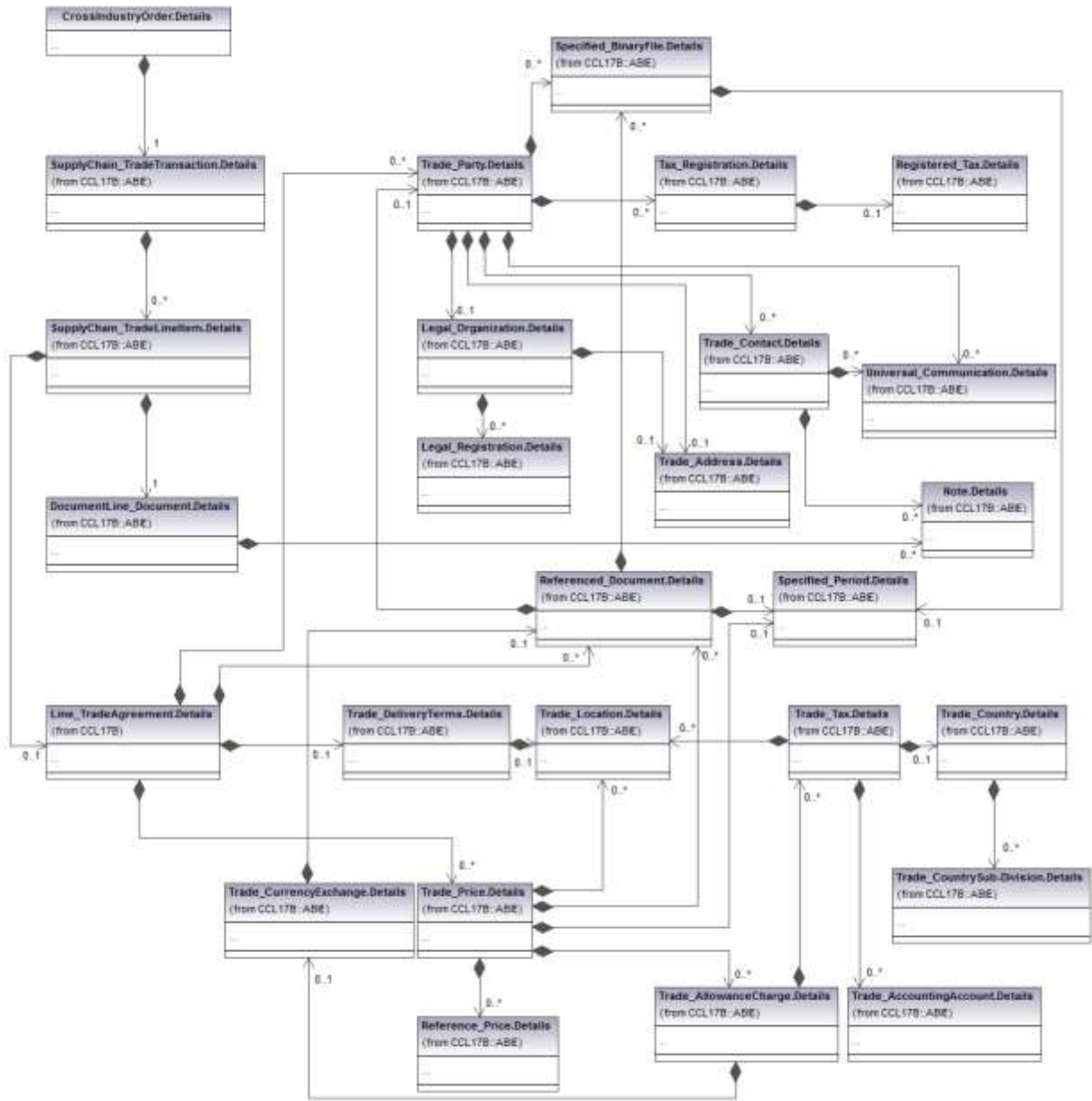

284
 285
 286
 287
 288
 289



317 **Figure 9 Trade Product**
 318

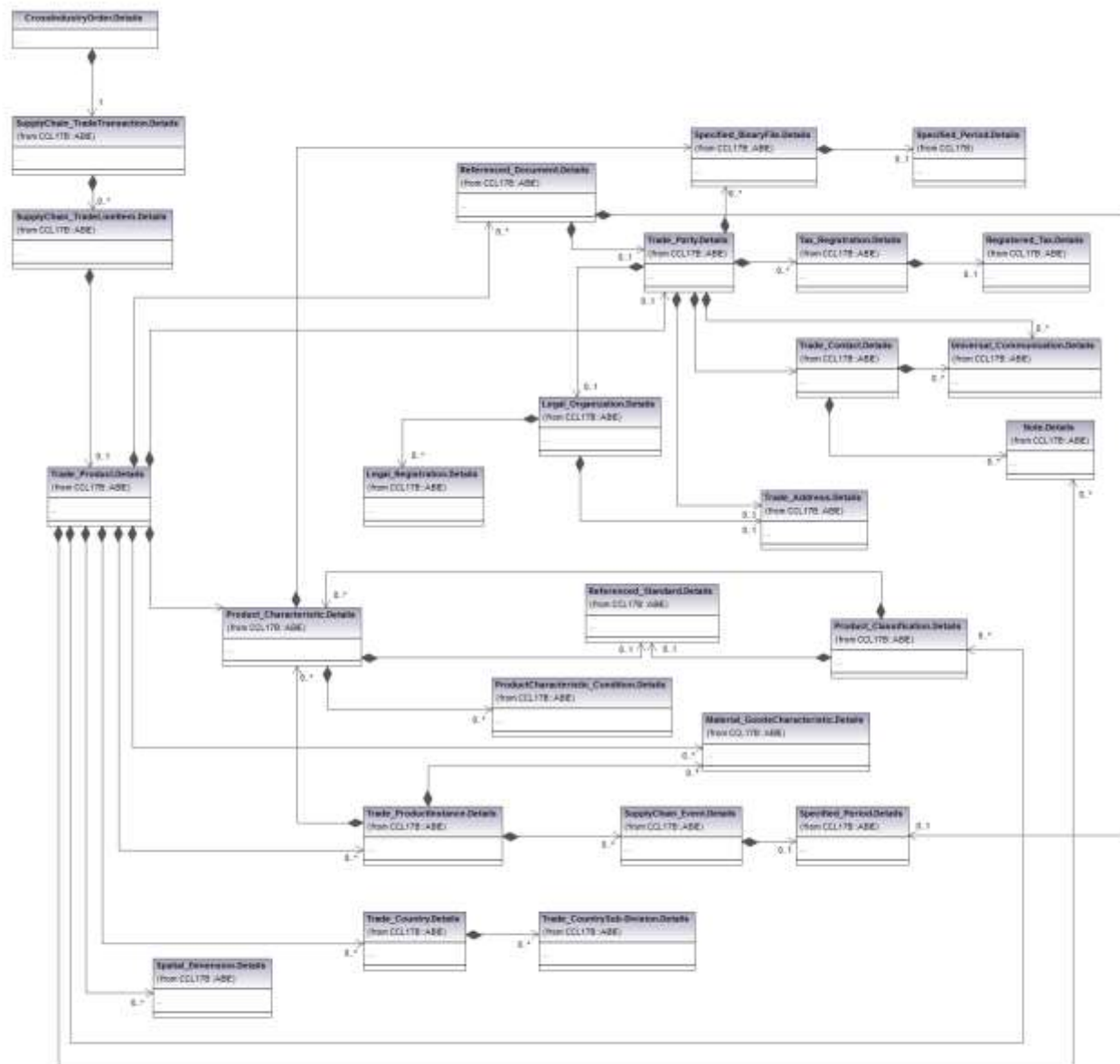

319
 320

7.3 New and Changed Components

321 The new and changed components for the Cross Industry Order will be identified by the SCRDM (Supply
 322 Chain Reference Data Model) project.
 323

7.4 Detailed class diagrams

324 Below diagrams are detailing the CCTS Business Information Entities (BIEs) identified as part of the
 325 Cross Industry Order. Compared to the canonical data model, as presented earlier, these multiple
 326 diagrams are broken down in a logical fashion. The Class Diagrams show the Aggregate Business
 327 Information Entity, and its properties (Basic Business Information Entities and its Association
 328 Business Information Entities), and relevant cardinalities.
 329
 330
 331
 332

333
334

Figure 10 Cross Industry Order (root elements)

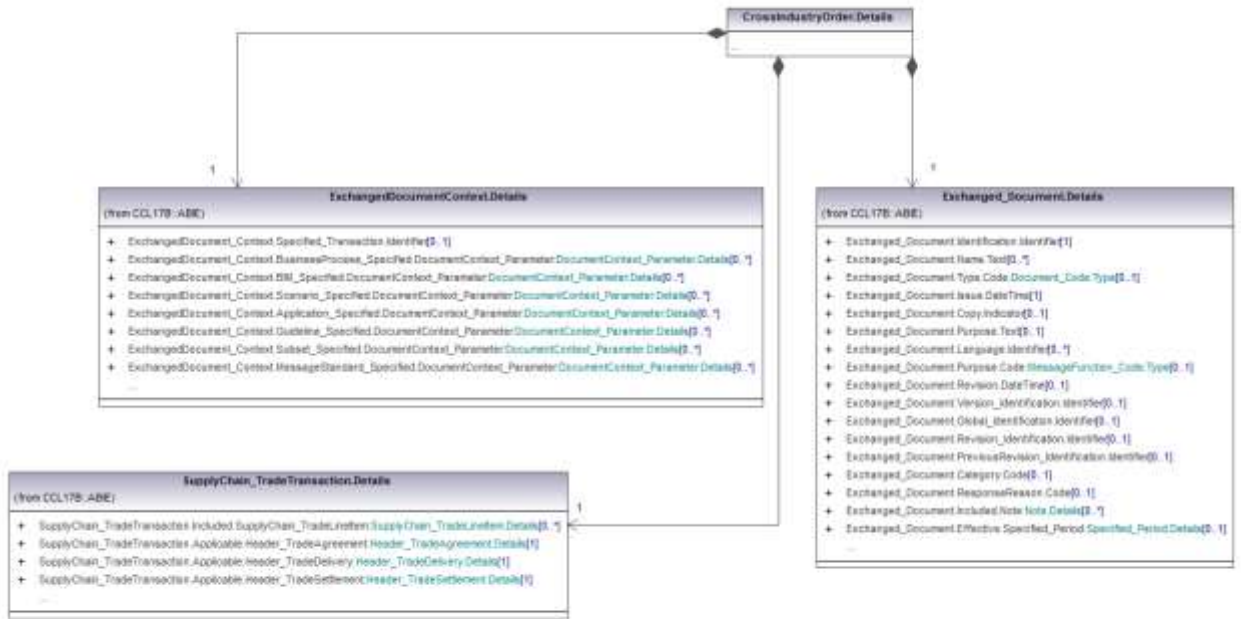

335
336
337
338
339
340
341
342
343
344
345
346
347
348

Public R

353
354
355

Figure 12 Header Trade Agreement

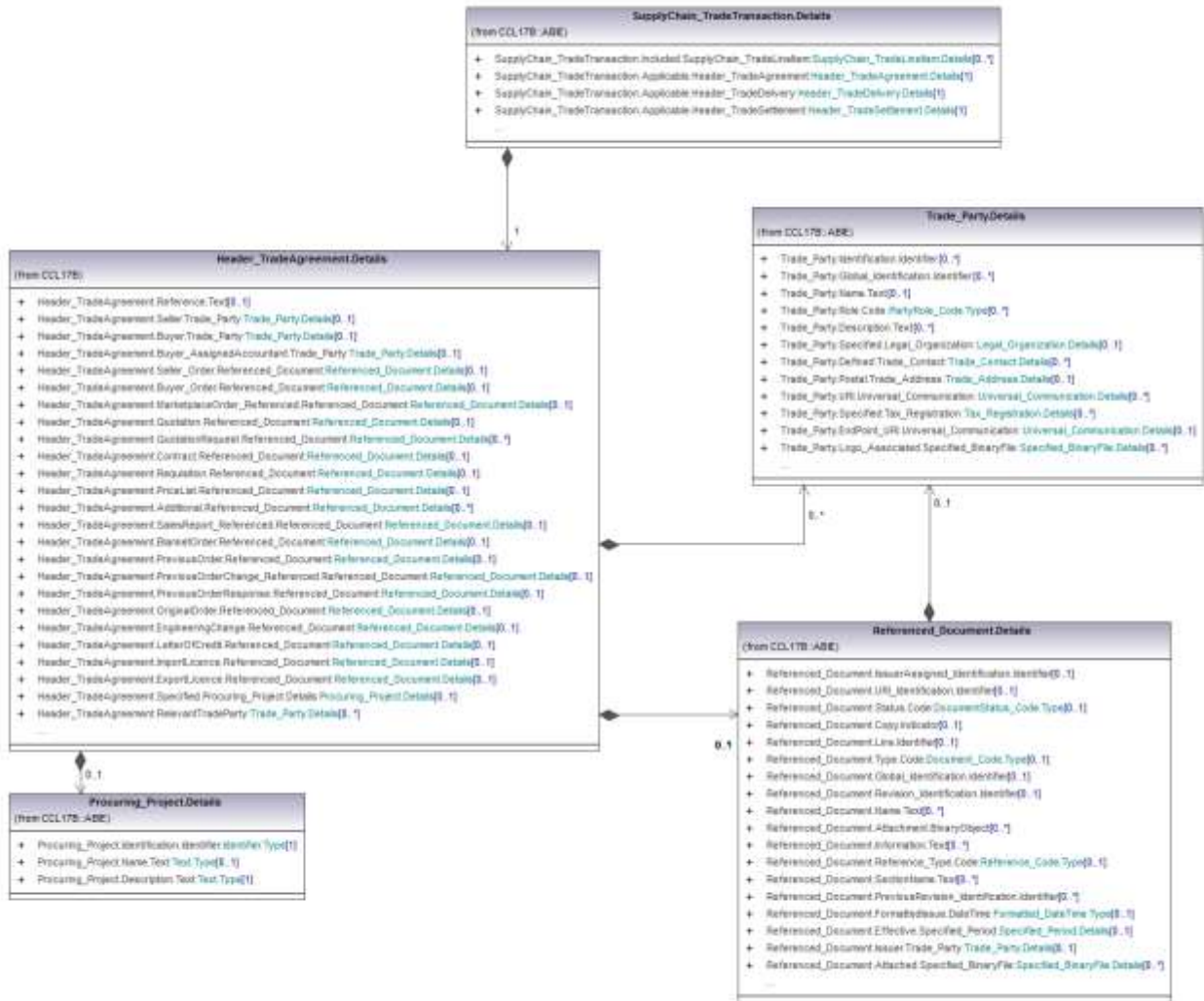

356
357
358
359
360
361
362
363
364
365
366
367
368
369
370
371
372
373

374
375
376

Figure 13 Header Trade Delivery



377
378
379



380
381

Figure 14 Header Trade Settlement

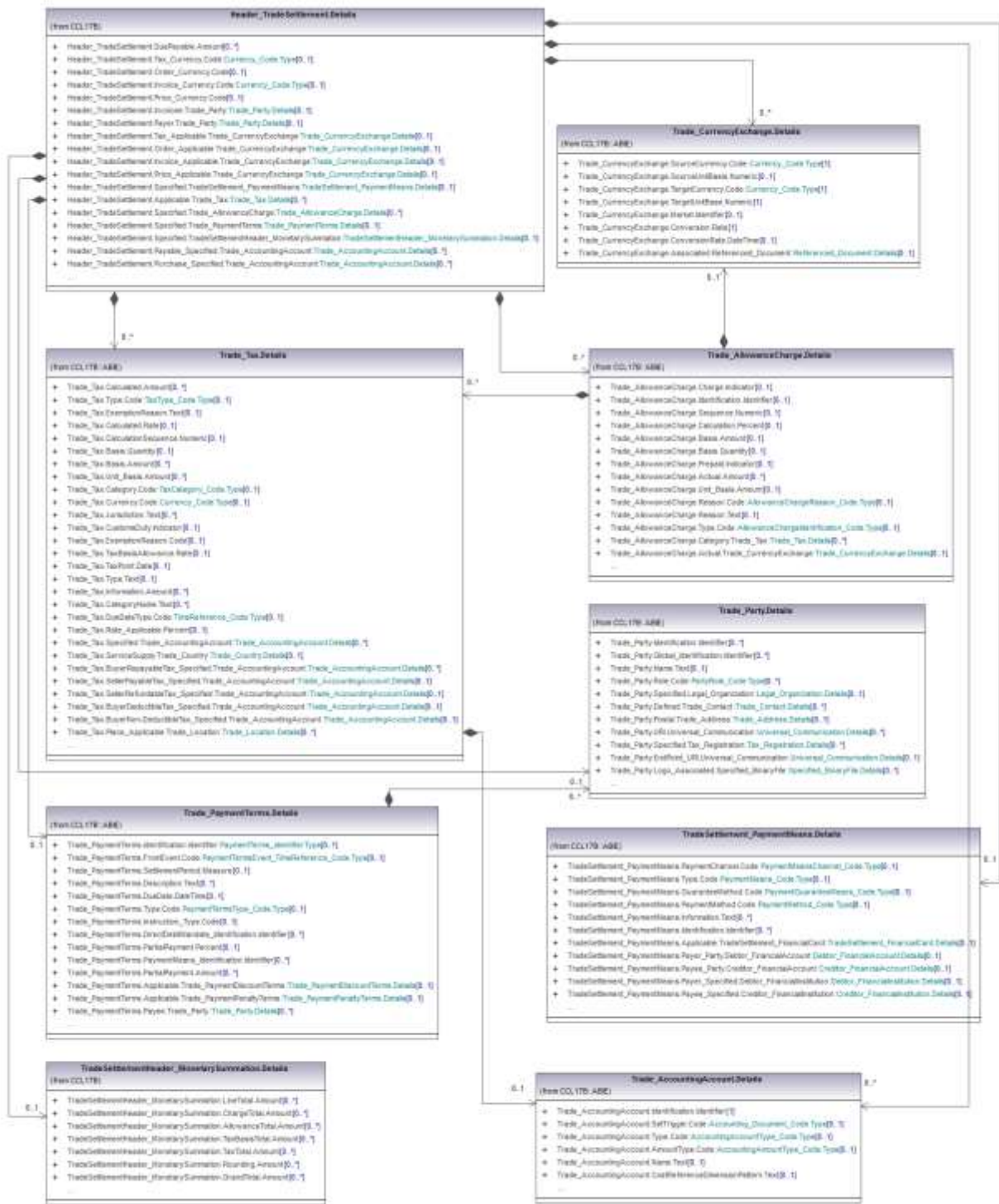

382
383
384
385
386
387

388 Figure 15 Trade Line Item



389
390
391
392
393
394
395
396
397
398
399
400
401
402
403
404
405

Public K

406 Figure 16 Line Trade Agreement

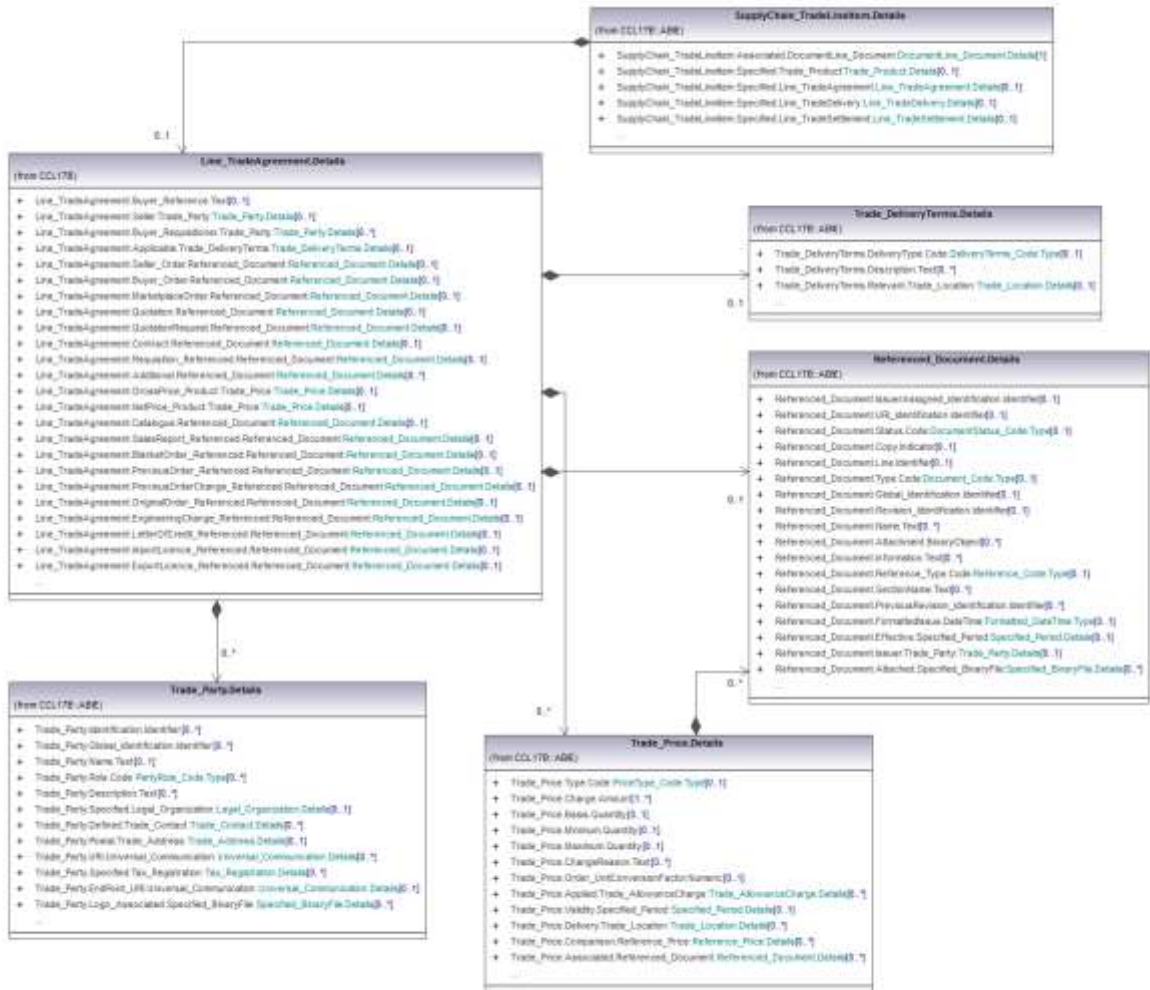

407
408
409
410
411
412
413
414
415
416
417
418
419
420
421
422

Public

428 **Figure 18 Line Trade Settlement**
429

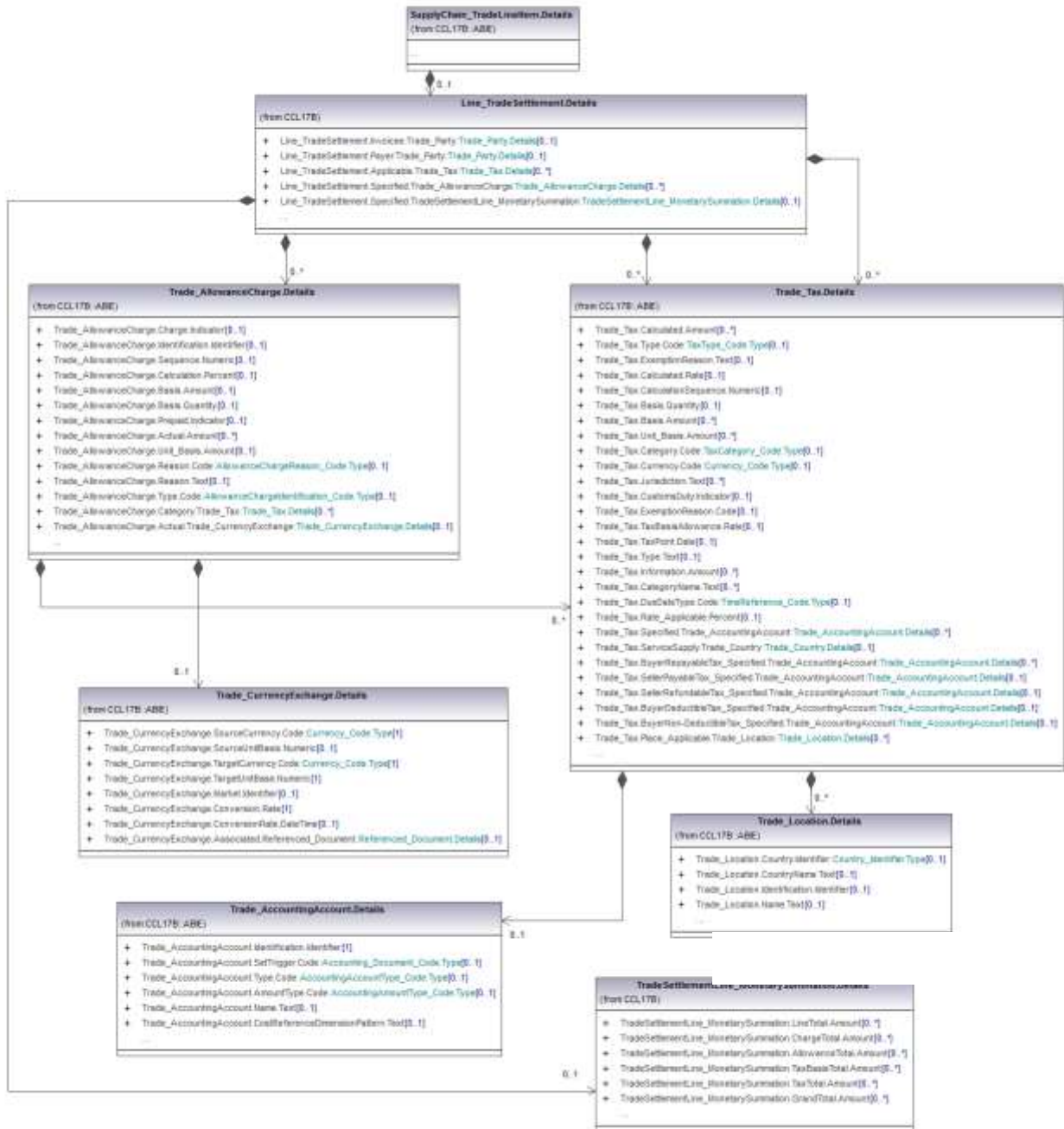

430
431



432 **7.6 Core Components Model Extract**

433 Not applicable

434 **7.6.1.1 New and Changed Components**

435 Not applicable

436 **7.6.1.2 New and Changed Core Data Types**

437 Not applicable

438 **7.6.1.3 Presentation**

439 Not applicable

440 **7.7 Logical Message Structure**441 **7.7.1 Message Assembly**

442 The purpose of this section is to describe the content or business information payload of each
 443 message by showing the top level ABIEs that connect to the root of the message.

444 The following messages are defined:

- 445 • Cross Industry Order (CIO)
- 446 • Cross Industry Order Change (CIOC)
- 447 • Cross Industry Order Response (CIOR)

448

449

450

Table 4 Order Message Assembly Realization Table

Type MA/ASMA	Dictionary Entry Name	Definition	Message Name Qualifier(s)	Message Name	Occurrence Min	Occurrence Max
MA	Cross Industry_ Order. Details	The Cross Industry Order message.	Cross Industry	Order		
ASMA	Cross Industry_ Order. Exchanged Document_ Context	The scenario or setting of an exchanged document, such as its business process application context.	Cross Industry	Order	0	1
ASMA	Cross Industry_ Order. Exchanged_ Document	A collection of data for a Cross Industry Order header that is exchanged between two or more parties in written, printed or electronic form.	Cross Industry	Order	1	1
ASMA	Cross Industry_ Order. Supply Chain_ Trade Transaction	The trade line items, trade agreement, trade delivery and trade settlement details included in this Cross Industry Order Header.	Cross Industry	Order	1	1

451

452

453

Table 5 Order Change Message Assembly Realization Table

Type MA/ASMA	Dictionary Entry Name	Definition	Message Name Qualifier(s)	Message Name	Occurrence Min	Occurrence Max
MA	Cross Industry_ Order Change. Details	The Cross Industry Order Change message.	Cross Industry	Order Change		
ASMA	Cross Industry_ Order Change. Exchanged Document_ Context	The scenario or setting of an exchanged document, such as its business process application	Cross Industry	Order Change	0	1
ASMA	Cross Industry_ Order Change. Exchanged_ Document	A collection of data for a Cross Industry Order Change header that is exchanged between two or more parties in written, printed or electronic form.	Cross Industry	Order Change	1	1
ASMA	Cross Industry_ Order Change. Supply Chain_ Trade Transaction	The trade line items, trade agreement, trade delivery and trade settlement details included in this Cross Industry Order Change Header.	Cross Industry	Order Change	1	1

454
455
456
457**Table 6 Order Response Message Assembly Realization Table**

Type MA/ASMA	Dictionary Entry Name	Definition	Message Name Qualifier(s)	Message Name	Occurrence Min	Occurrence Max
MA	Cross Industry_ Order Response. Details	The Cross Industry Order Response message.	Cross Industry	Order Response		
ASMA	Cross Industry_ Order Response. Exchanged Document_ Context	The scenario or setting of an exchanged document, such as its business process application context.	Cross Industry	Order Response	0	1
ASMA	Cross Industry_ Order Response. Exchanged_ Document	A collection of data for a Cross Industry Order Response header that is exchanged between two or more parties in written, printed or electronic form.	Cross Industry	Order Response	1	1
ASMA	Cross Industry_ Order Response. Supply Chain_ Trade Transaction	The trade line items, trade agreement, trade delivery and trade settlement details included in this Cross Industry Order Response Header.	Cross Industry	Order Response	1	1

458
459CCBDA Cross
Industry Order MA460
461
462

CCBDA Cross Industry Order, Order Change, Order Response Message Assemblyv1.xls

463 8 Business Information Entities Used

464 This section provides a complete listing of ABIEs required for all the messages defined in this RSM
465 showing the ABIEs, Properties and Associations, their Dictionary Entry Names and cardinalities.

466 The following table of Aggregate Business Information Entities (ABIEs) represents the Business
467 Information Entities used in the Cross Industry Order (CIO), Cross Industry Order Change (CIOC)
468 and Cross Industry Order Response (CIOR) message.

469 Below, embedded excel file includes the CCL ABIE's and their relationship to the message Business
470 Information Entities (MBIE's). Restrictions on the CCL ABIE's are shown in this file.



Relationship CCL
ABIE CCBDA Order M

471
472
473 Relationship CCL ABIE - CCBDA CIO CIOC CIOR MBIE.xlsx

474
475

Table 7 BIEs used in Order Messages

ABIE/ BBIE/ ASBIE	Dictionary Entry Name	Short Name	Definition	TDED	Qualified Data Type UID	Occurrence MIN	Occurrence Max
ABIE							
BBIE							
ASBIE							
ABIE	Acknowledgement_ Document. Details	Acknowledgement Document	A document exchanged between parties for a business application level acknowledgement of the receipt of information.			0	0
BBIE	Acknowledgement_ Document. Identification. Identifier	ID	The unique identifier of this acknowledgement document.	(1004)		0	1
BBIE	Acknowledgement_ Document. Type. Code	Type Code	A code specifying a type of acknowledgement document.	(1001)	UN02000006	0	unbounded
BBIE	Acknowledgement_ Document. Acknowledgement_ Status. Code	Acknowledgement Status Code	A code specifying an acknowledgment status for this acknowledgement document.	(1225)	UN02000020	0	unbounded
BBIE	Acknowledgement_ Document. Reason_ Information. Text	Reason Information Text	Reason information, expressed as text, for this acknowledgement document.	(9013)		0	unbounded
ABIE	Branch_ Financial Institution. Details	Branch Financial Institution	A sub-division of a bank, building society, credit union, stock brokerage, or similar business; established primarily to provide financial services and financial transactions.				
BBIE	Branch_ Financial Institution. Identification. Identifier	ID	The unique identifier for this branch of a financial institution.	(3433)		0	1
BBIE	Branch_ Financial Institution. Name. Text	Name	The name, expressed as text, for this branch of a financial institution.	(3432)		0	1
ASBIE	Branch_ Financial Institution. Location. Financial Institution_ Address	Address	The location address for this branch of a financial institution.			0	1

ABIE/ BBIE/ ASBIE	Dictionary Entry Name	Short Name	Definition	TDED	Qualified Data Type UID	Occurrence MIN	Occurrence Max
ABIE	Contact_ Person. Details	Contact Person	An individual human being in a position to give assistance or information.				
BBIE	Contact_ Person. Given Name. Text	Given Name	The name, expressed as text, given to this contact person, usually by parents at birth.	(3460)		0	1
BBIE	Contact_ Person. Middle Name. Text	Middle Name	The middle name, expressed as text, of this contact person, usually given by parents at birth.			0	1
BBIE	Contact_ Person. Family Name. Text	Family Name	The name, expressed as text, that this contact person shares with members of his/her family.	(3500)		0	1
ABIE	Creditor_ Financial Account. Details	Creditor Financial Account	A specific business arrangement whereby credits arising from transactions are recorded.				
BBIE	Creditor_ Financial Account. IBAN_ Identification. Identifier	IBAN ID	The unique International Bank Account Number (IBAN) identifier for this creditor financial account.	(3492)		0	1
BBIE	Creditor_ Financial Account. Type. Code	Type Code	The code specifying the type of creditor financial account.	(4437)		0	1
BBIE	Creditor_ Financial Account. Account Name. Text	Name	The account name, expressed as text, of this creditor financial account.			0	1
BBIE	Creditor_ Financial Account. Proprietary_ Identification. Identifier	Proprietary ID	The unique proprietary identifier for this creditor financial account.	(3492)		0	1
ABIE	Creditor_ Financial Institution. Details	Creditor Financial Institution	A bank, building society, credit union, stock brokerage, or similar business of the party that receives money.				
BBIE	Creditor_ Financial Institution. BIC. Identifier	BIC ID	The unique Bank Identification Code (BIC) as defined in ISO 9362 for this creditor financial institution.	(3433)		0	1

ABIE/ BBIE/ ASBIE	Dictionary Entry Name	Short Name	Definition	TDED	Qualified Data Type UID	Occurrence MIN	Occurrence Max
BBIE	Creditor_Financial Institution. CHIPS Universal_ Identification. Identifier	CHIPS Universal ID	The unique (United States) Clearing House Interbank Payments System (CHIPS) Universal Identification (UID) as assigned by the New York Clearing House for this creditor financial institution.	(3433)		0	1
BBIE	Creditor_Financial Institution. New Zealand NCC_ Identification. Identifier	New Zealand NCC ID	The unique New Zealand National Clearing Code (NCC) identifier as assigned by the New Zealand Bankers' Association (NZBA) for this creditor financial institution.	(3433)		0	1
BBIE	Creditor_Financial Institution. Irish NSC_ Identification. Identifier	Irish NSC ID	The unique Irish National Sorting Code (NSC) identifier as assigned by the Irish Payments Services Organisation (IPSO) for this creditor financial institution.	(3433)		0	1
BBIE	Creditor_Financial Institution. UK Sort Code_ Identification. Identifier	UK Sort Code ID	The unique United Kingdom (UK) Sort Code identifier as assigned by the UK Payment Association (APACS) for this creditor financial institution.	(3433)		0	1
BBIE	Creditor_Financial Institution. CHIPS Participant_ Identification. Identifier	CHIPS Participant ID	The unique (United States) Clearing House Interbank Payment System (CHIPS) Participant Identifier (ID) as assigned by the New York Clearing House for this creditor financial institution.	(3433)		0	1
BBIE	Creditor_Financial Institution. Swiss BC_ Identification. Identifier	Swiss BC ID	The unique Swiss Bank Code (BC) identifier for this creditor financial institution.	(3433)		0	1
BBIE	Creditor_Financial Institution. Fedwire Routing Number_ Identification. Identifier	Fedwire Routing Number ID	The unique Fedwire Routing Number identifier as assigned by the American Bankers Association (ABA) for this creditor financial institution.	(3433)		0	1

ABIE/ BBIE/ ASBIE	Dictionary Entry Name	Short Name	Definition	TDED	Qualified Data Type UID	Occurrence MIN	Occurrence Max
BBIE	Creditor_ Financial Institution. Portuguese NCC_ Identification. Identifier	Portuguese NCC ID	The unique Portuguese National Clearing Code (NCC) identifier for this creditor financial institution.	(3433)		0	1
BBIE	Creditor_ Financial Institution. Russian Central Bank_ Identification. Identifier	Russian Central Bank ID	The unique Russian Central Bank Identification Code identifier for this creditor financial institution.	(3433)		0	1
BBIE	Creditor_ Financial Institution. Italian Domestic_ Identification. Identifier	Italian Domestic ID	The unique Italian Domestic Identification Code identifier as assigned by the Associazione Bancaria Italiana (ABI) for this creditor financial institution.	(3433)		0	1
BBIE	Creditor_ Financial Institution. Austrian Bankleitzahl_ Identification. Identifier	Austrian Bankleitzahl ID	The unique Austrian Bankleitzahl identifier for this creditor financial institution.	(3433)		0	1
BBIE	Creditor_ Financial Institution. Canadian Payments Association_ Identification. Identifier	Canadian Payments Association ID	The unique Canadian Payments Association Routing Number identifier for this creditor financial institution.	(3433)		0	1
BBIE	Creditor_ Financial Institution. SIC_ Identification. Identifier	SIC ID	The unique Swiss Interbank Clearing (SIC) Code identifier for this creditor financial institution.	(3433)		0	1
BBIE	Creditor_ Financial Institution. German Bankleitzahl_ Identification. Identifier	German Bankleitzahl ID	The unique German Bankleitzahl identifier for this creditor financial institution.	(3433)		0	1
BBIE	Creditor_ Financial Institution. Spanish Domestic Interbanking_ Identification. Identifier	Spanish Domestic Interbanking ID	The unique Spanish Domestic Interbanking Code identifier as assigned by the Centro de Cooperacion Interbancaria (CCI) for this creditor financial institution.	(3433)		0	1
BBIE	Creditor_ Financial Institution. South African NCC_ Identification. Identifier	South African NCC ID	The unique South African National Clearing Code (NCC) identifier as assigned by the South African Bankers Services Company Ltd. (BankServ) for this creditor financial institution.	(3433)		0	1

ABIE/ BBIE/ ASBIE	Dictionary Entry Name	Short Name	Definition	TDED	Qualified Data Type UID	Occurrence MIN	Occurrence Max
BBIE	Creditor_ Financial Institution. Hong Kong Bank_ Identification. Identifier	Hong Kong Bank ID	The unique Hong Kong Bank Code identifier for this creditor financial institution.	(3433)		0	1
BBIE	Creditor_ Financial Institution. Australian BSB_ Identification. Identifier	Australian BSB ID	The unique Australian Bank State Branch (BSB) Code identifier as assigned by the Australian Payments Clearing Association (APCA) for this creditor financial institution.	(3433)		0	1
BBIE	Creditor_ Financial Institution. Indian Financial System_ Identification. Identifier	Indian Financial System ID	The unique Indian Financial System Code identifier for this creditor financial institution.	(3433)		0	1
BBIE	Creditor_ Financial Institution. Hellenic Bank_ Identification. Identifier	Hellenic Bank ID	The unique Hellenic Bank Identification Code identifier for this creditor financial institution.	(3433)		0	1
BBIE	Creditor_ Financial Institution. Polish National Clearing_ Identification. Identifier	Polish National Clearing ID	The unique Polish National Clearing Code identifier for this creditor financial institution.	(3433)		0	1
BBIE	Creditor_ Financial Institution. Name. Text	Name	The name, expressed as text, for this creditor financial institution.	(3432)		0	1
BBIE	Creditor_ Financial Institution. Clearing System Name. Text	Clearing System Name	The clearing system name, expressed as text, for this creditor financial institution.			0	1
BBIE	Creditor_ Financial Institution. Japan Financial Institution Common_ Identification. Identifier	Japan Financial Institution Common ID	The Japan Financial Institution Common identifier as assigned by the Japanese Bankers Association for this creditor financial institution.	(3433)		0	1
ASBIE	Creditor_ Financial Institution. Location. Financial Institution_ Address	Address	The location address for this creditor financial institution.			0	1
ASBIE	Creditor_ Financial Institution. Sub-Division. Branch_ Financial Institution	Branch	The branch financial institution for this creditor financial institution.			0	1

ABIE/ BBIE/ ASBIE	Dictionary Entry Name	Short Name	Definition	TDED	Qualified Data Type UID	Occurrence MIN	Occurrence Max
ABIE	Debtor_ Financial Account. Details	Debtor Financial Account	A specific business arrangement whereby debits arising from transactions are recorded.				
BBIE	Debtor_ Financial Account. IBAN_ Identification. Identifier	IBAN ID	The unique International Bank Account Number (IBAN) identifier for this debtor financial account.	(3492)		0	1
BBIE	Debtor_ Financial Account. Type. Code	Type Code	The code specifying the type of debtor financial account.	(4437)		0	1
BBIE	Debtor_ Financial Account. Account Name. Text	Name	The account name, expressed as text, of this debtor financial account.			0	1
BBIE	Debtor_ Financial Account. Proprietary_ Identification. Identifier	Proprietary ID	The unique proprietary identifier for this debtor financial account.	(3492)		0	1
ABIE	Debtor_ Financial Institution. Details	Debtor Financial Institution	A bank, building society, credit union, stock brokerage, or similar business of the party that owes money.				
BBIE	Debtor_ Financial Institution. BIC. Identifier	BIC ID	The unique Bank Identification Code (BIC) as defined in ISO 9362 for this debtor financial institution.	(3433)		0	1
BBIE	Debtor_ Financial Institution. Clearing System Name. Text	Clearing System Name	The clearing system name, expressed as text, for this debtor financial institution.			0	1
BBIE	Debtor_ Financial Institution. CHIPS Universal_ Identification. Identifier	CHIPS Universal ID	The unique (United States) Clearing House Interbank Payments System (CHIPS) Universal Identification (UID) as assigned by the New York Clearing House for this debtor financial institution.	(3433)		0	1
BBIE	Debtor_ Financial Institution. New Zealand NCC_ Identification. Identifier	New Zealand NCC ID	The unique New Zealand National Clearing Code (NCC) identifier as assigned by the New Zealand Bankers' Association (NZBA) for this debtor financial institution.	(3433)		0	1

ABIE/ BBIE/ ASBIE	Dictionary Entry Name	Short Name	Definition	TDED	Qualified Data Type UID	Occurrence MIN	Occurrence Max
BBIE	Debtor_ Financial Institution. Irish NSC_ Identification. Identifier	Irish NSC ID	The unique Irish National Sorting Code (NSC) identifier as assigned by the Irish Payments Services Organisation (IPSO) for this debtor financial institution.	(3433)		0	1
BBIE	Debtor_ Financial Institution. UK Sort Code_ Identification. Identifier	UK Sort Code ID	The unique United Kingdom (UK) Sort Code identifier as assigned by the UK Payment Association (APACS) for this debtor financial institution.	(3433)		0	1
BBIE	Debtor_ Financial Institution. CHIPS Participant_ Identification. Identifier	CHIPS Participant ID	The unique (United States) Clearing House Interbank Payment System (CHIPS) Participant Identifier (ID) as assigned by the New York Clearing House for this debtor financial institution.	(3433)		0	1
BBIE	Debtor_ Financial Institution. Swiss BC_ Identification. Identifier	Swiss BC ID	The unique Swiss Bank Code (BC) identifier for this debtor financial institution.	(3433)		0	1
BBIE	Debtor_ Financial Institution. Fedwire Routing Number_ Identification. Identifier	Fedwire Routing Number ID	The unique Fedwire Routing Number identifier as assigned by the American Bankers Association (ABA) for this debtor financial institution.	(3433)		0	1
BBIE	Debtor_ Financial Institution. Portuguese NCC_ Identification. Identifier	Portuguese NCC ID	The unique Portuguese National Clearing Code (NCC) identifier for this debtor financial institution.	(3433)		0	1
BBIE	Debtor_ Financial Institution. Russian Central Bank_ Identification. Identifier	Russian Central Bank ID	The unique Russian Central Bank Identification Code identifier for this debtor financial institution.	(3433)		0	1
BBIE	Debtor_ Financial Institution. Italian Domestic_ Identification. Identifier	Italian Domestic ID	The unique Italian Domestic Identification Code identifier as assigned by the Associazione Bancaria Italiana (ABI) for this debtor financial institution.	(3433)		0	1

ABIE/ BBIE/ ASBIE	Dictionary Entry Name	Short Name	Definition	TDED	Qualified Data Type UID	Occurrence MIN	Occurrence Max
BBIE	Debtor_ Financial Institution. Austrian Bankleitzahl_ Identification. Identifier	Austrian Bankleitzahl ID	The unique Austrian Bankleitzahl identifier for this debtor financial institution.	(3433)		0	1
BBIE	Debtor_ Financial Institution. Canadian Payments Association_ Identification. Identifier	Canadian Payments Association ID	The unique Canadian Payments Association Routing Number identifier for this debtor financial institution.	(3433)		0	1
BBIE	Debtor_ Financial Institution. SIC_ Identification. Identifier	SIC ID	The unique Swiss Interbank Clearing (SIC) Code identifier for this debtor financial institution.	(3433)		0	1
BBIE	Debtor_ Financial Institution. German Bankleitzahl_ Identification. Identifier	German Bankleitzahl ID	The unique German Bankleitzahl identifier for this debtor financial institution.	(3433)		0	1
BBIE	Debtor_ Financial Institution. Spanish Domestic Interbanking_ Identification. Identifier	Spanish Domestic Interbanking ID	The unique Spanish Domestic Interbanking Code identifier as assigned by the Centro de Cooperacion Interbancaria (CCI) for this debtor financial institution.	(3433)		0	1
BBIE	Debtor_ Financial Institution. South African NCC_ Identification. Identifier	South African NCC ID	The unique South African National Clearing Code (NCC) identifier as assigned by the South African Bankers Services Company Ltd. (BankServ) for this debtor financial institution.	(3433)		0	1
BBIE	Debtor_ Financial Institution. Hong Kong Bank_ Identification. Identifier	Hong Kong Bank ID	The unique Hong Kong Bank Code identifier for this debtor financial institution.	(3433)		0	1
BBIE	Debtor_ Financial Institution. Australian BSB_ Identification. Identifier	Australian BSB ID	The unique Australian Bank State Branch (BSB) Code identifier as assigned by the Australian Payments Clearing Association (APCA) for this debtor financial institution.	(3433)		0	1
BBIE	Debtor_ Financial Institution. Indian Financial System_ Identification. Identifier	Indian Financial System ID	The unique Indian Financial System Code identifier for this debtor financial institution.	(3433)		0	1

ABIE/ BBIE/ ASBIE	Dictionary Entry Name	Short Name	Definition	TDED	Qualified Data Type UID	Occurrence MIN	Occurrence Max
BBIE	Debtor_ Financial Institution. Hellenic Bank_ Identification. Identifier	Hellenic Bank ID	The unique Hellenic Bank Identification Code identifier for this debtor financial institution.	(3433)		0	1
BBIE	Debtor_ Financial Institution. Polish National Clearing_ Identification. Identifier	Polish National Clearing ID	The unique Polish National Clearing Code identifier for this debtor financial institution.	(3433)		0	1
BBIE	Debtor_ Financial Institution. Name. Text	Name	The name, expressed as text, for this debtor financial institution.	(3432)		0	1
BBIE	Debtor_ Financial Institution. Japan Financial Institution Common_ Identification. Identifier	Japan Financial Institution Common ID	The Japan Financial Institution Common identifier as assigned by the Japanese Bankers Association for this debtor financial institution.	(3433)		0	1
ASBIE	Debtor_ Financial Institution. Location. Financial Institution_ Address	Address	The location address for this debtor financial institution.			0	1
ASBIE	Debtor_ Financial Institution. Sub-Division. Branch_ Financial Institution	Branch	The branch financial institution for this debtor financial institution.			0	1
ABIE	Delivery_ Instructions. Details	Delivery Instructions	Delivery information of an instructive nature.				
BBIE	Delivery_ Instructions. Handling. Code	Handling Code	A code specifying delivery handling instructions.			0	unbounded
BBIE	Delivery_ Instructions. Handling. Text	Handling Text	Delivery handling instructions expressed as text.			0	unbounded
BBIE	Delivery_ Instructions. Description. Text	Description	A textual description of these delivery instructions.	(4400)		0	unbounded
BBIE	Delivery_ Instructions. Description. Code	Description Code	The code specifying a description of these delivery instructions.	(4401)		0	1
ABIE	Document Context_ Parameter. Details	Document Context Parameter	A feature that is fixed for a particular document context.				
BBIE	Document Context_ Parameter. Identification. Identifier	ID	The unique identifier of this document context parameter.			0	1

ABIE/ BBIE/ ASBIE	Dictionary Entry Name	Short Name	Definition	TDED	Qualified Data Type UID	Occurrence MIN	Occurrence Max
BBIE	Document Context_ Parameter. Value. Text	Value Text	The value, expressed as text, of this document context parameter.			0	1
ASBIE	Document Context_ Parameter. Specified. Document_ Version	Version	The document version specified for this document context parameter.			0	1
ABIE	Document Line_ Document. Details	Document Line	A collection of data for a line on a piece of written, printed or electronic matter that provides information or evidence.				
BBIE	Document Line_ Document. Line. Identifier	Line ID	The unique identifier of this document line.	(1156)		1	1
BBIE	Document Line_ Document. UUID_ Line. Identifier	UUID Line ID	The universally unique identifier (UUID) of this document line.	(1156)		0	1
BBIE	Document Line_ Document. Line Status. Code	Status Code	The code specifying the status of this document line.	(1073)	UN02000124	0	1
BBIE	Document Line_ Document. Line Status Reason. Code	Status Reason Code	The code specifying the line status reason for this document line.			0	1
BBIE	Document Line_ Document. Identification. Identifier	ID	The identifier of this document line document.	(1004)		0	1
ASBIE	Document Line_ Document. Included. Note	Note	A note included in this document line.			0	unbounded
ASBIE	Document Line_ Document. Reference. Acknowledgement_ Document	Acknowledgement Document	The acknowledgement document referenced in this document line.			0	1
ABIE	Document_ Version. Details	Document Version	A specific variant of a document.				
BBIE	Document_ Version. Identification. Identifier	ID	The unique identifier for this document version.			0	1
BBIE	Document_ Version. Name. Text	Name	The name, expressed as text, of this document version.			0	1
BBIE	Document_ Version. Issue. Date Time	Issue Date Time	The date, time, date and time or other date time value of issue of this document version.			0	1

ABIE/ BBIE/ ASBIE	Dictionary Entry Name	Short Name	Definition	TDED	Qualified Data Type UID	Occurrence MIN	Occurrence Max
ABIE	Exchanged Document_ Context. Details	Exchanged Document Context	The scenario or setting of an exchanged document, such as its business process application context.				
BBIE	Exchanged Document_ Context. Specified_ Transaction. Identifier	Transaction ID	The identifier of a specified transaction in this exchanged document context.			0	1
ASBIE	Exchanged Document_ Context. Business Process_ Specified. Document Context_ Parameter	Business Process	A business process context parameter specified for this exchanged document context.			0	unbounded
ASBIE	Exchanged Document_ Context. BIM_ Specified. Document Context_ Parameter	BIM	A Business Information Master (BIM) context parameter specified for this exchanged document context.			0	unbounded
ASBIE	Exchanged Document_ Context. Scenario_ Specified. Document Context_ Parameter	Scenario	A scenario context parameter specified for this exchanged document context.			0	unbounded
ASBIE	Exchanged Document_ Context. Application_ Specified. Document Context_ Parameter	Application	An application context parameter specified for this exchanged document context.			0	unbounded
ASBIE	Exchanged Document_ Context. Guideline_ Specified. Document Context_ Parameter	Guideline	A guideline context parameter specified for this exchanged document context.			0	unbounded
ASBIE	Exchanged Document_ Context. Subset_ Specified. Document Context_ Parameter	Subset	A subset context parameter specified for this exchanged document context.			0	unbounded
ASBIE	Exchanged Document_ Context. Message Standard_ Specified. Document Context_ Parameter	Message Standard	The message standard document context parameter specified for this exchanged document context.			0	1
ABIE	Exchanged_ Document. Details	Exchanged Document	A collection of data for a piece of written, printed or electronic matter that is exchanged between two or more parties.				
BBIE	Exchanged_ Document. Identification. Identifier	ID	The unique identifier of this exchanged document.	(1004)		1	1

ABIE/ BBIE/ ASBIE	Dictionary Entry Name	Short Name	Definition	TDED	Qualified Data Type UID	Occurrence MIN	Occurrence Max
BBIE	Exchanged_ Document. Name. Text	Name	A name, expressed as text, of this exchanged document.	(1000)		0	unbounded
BBIE	Exchanged_ Document. Type. Code	Type Code	The code specifying the type of exchanged document.	(1001)	UN02000006	0	1
BBIE	Exchanged_ Document. Issue. Date Time	Issue Date Time	The date, time, date time or other date time value for the issuance of this exchanged document.	(2007)		1	1
BBIE	Exchanged_ Document. Copy. Indicator	Copy Indicator	The indication of whether or not this exchanged document is a copy.	(4366)		0	1
BBIE	Exchanged_ Document. Purpose. Text	Purpose Text	The purpose, expressed as text, of this exchanged document. ¹	(1160)		0	1
BBIE	Exchanged_ Document. Language. Identifier	Language Code	A unique identifier for a language used in this exchanged document.	[3453]		0	unbounded
BBIE	Exchanged_ Document. Purpose. Code	Purpose Code	A code specifying the purpose of this exchanged document, such as request or reminder.	(1225)	UN02000125	0	1
BBIE	Exchanged_ Document. Revision. Date Time	Revision Date Time	The date, time, date time or other date time value for the revision of this exchanged document.			0	1
BBIE	Exchanged_ Document. Version_ Identification. Identifier	Version ID	The unique identifier for the version of this exchanged document.	(1004)		0	1
BBIE	Exchanged_ Document. Global_ Identification. Identifier	Global ID	The unique global identifier for this exchanged document.	(1004)		0	1
BBIE	Exchanged_ Document. Revision_ Identification. Identifier	Revision ID	The unique identifier of the revision of this exchanged document.	(1004)		0	1
BBIE	Exchanged_ Document. Previous Revision_ Identification. Identifier	Previous Revision ID	The unique identifier of the previous revision of this exchanged document.	(1004)		0	1

¹ Only used in Order Change

ABIE/ BBIE/ ASBIE	Dictionary Entry Name	Short Name	Definition	TDED	Qualified Data Type UID	Occurrence MIN	Occurrence Max
BBIE	Exchanged_ Document. Category. Code	Category Code	The code specifying a category for this exchanged document.	(1003)		0	1
BBIE	Exchanged_ Document. Response Reason. Code	Response Reason Code	A code specifying a response reason for this exchanged document.			0	1
ASBIE	Exchanged_ Document. Included. Note	Note	A note included in this exchanged document.			0	unbounded
ASBIE	Exchanged_ Document. Effective. Specified_ Period	Effective Period	The specified period within which this exchanged document is effective.			0	1
ABIE	Financial Institution_ Address. Details	Financial Institution Address	The location at which a financial institution may be found or reached.				
BBIE	Financial Institution_ Address. Postcode. Code	Postcode	The code specifying the postcode for this financial institution address.	(3251)		0	1
BBIE	Financial Institution_ Address. Building Number. Text	Building Number	The number, expressed as text, of the building on a street for this financial institution address.			0	1
BBIE	Financial Institution_ Address. Line One. Text	Line One	The first free form line, expressed as text, of this financial institution address.	(3286)		0	1
BBIE	Financial Institution_ Address. Line Two. Text	Line Two	The second free form line, expressed as text, of this financial institution address.	(3286)		0	1
BBIE	Financial Institution_ Address. Line Three. Text	Line Three	The third free form line, expressed as text, of this financial institution address.	(3286)		0	1
BBIE	Financial Institution_ Address. Line Four. Text	Line Four	The fourth free form line, expressed as text, of this financial institution address.	(3286)		0	1
BBIE	Financial Institution_ Address. Line Five. Text	Line Five	The fifth free form line, expressed as text, of this financial institution address.	(3286)		0	1
BBIE	Financial Institution_ Address. Street Name. Text	Street Name	The name, expressed as text, of the street or thoroughfare for this financial institution address.			0	1

ABIE/ BBIE/ ASBIE	Dictionary Entry Name	Short Name	Definition	TDED	Qualified Data Type UID	Occurrence MIN	Occurrence Max
BBIE	Financial Institution_ Address. City Name. Text	City Name	The name, expressed as text, of the city, town or village of this financial institution address.	(3164)		0	1
BBIE	Financial Institution_ Address. Country Sub-Division. Identifier	Country Sub-Division Code	The unique identifier of a country sub-division for this financial institution address (Reference ISO 3166 and UN/ECE Rec 3).	(3229)		0	1
BBIE	Financial Institution_ Address. Country. Identifier	Country Code	The unique identifier of a country for this financial institution address (Reference ISO 3166 and UN/ECE Rec 3).			0	1
BBIE	Financial Institution_ Address. Type. Code	Type Code	The code specifying the type of financial institution address.	(3131)		0	1
BBIE	Financial Institution_ Address. Department Name. Text	Department Name	The name, expressed as text, of a department within this financial institution address.			0	1
BBIE	Financial Institution_ Address. Post Office Box. Text	Post Office Box	The post office box, expressed as text, for this financial institution address.	(3042)		0	1
BBIE	Financial Institution_ Address. City. Identifier	City ID	The unique identifier of the city for this financial institution address, such as United Nations Location Code (UNLOCODE).			0	1
BBIE	Financial Institution_ Address. Country Sub-Division Name. Text	Country Sub-Division Name	The name, expressed as text, of a country sub-division within this financial institution address.	(3228)		0	1
BBIE	Financial Institution_ Address. Country Name. Text	Country Name	The name, expressed as text, of the country within this financial institution address.			0	1
ABIE	Geographical Coordinate. Details	Geographical Coordinate	A set of geographical coordinates of a specific point such as the longitude, latitude and altitude.				

ABIE/ BBIE/ ASBIE	Dictionary Entry Name	Short Name	Definition	TDED	Qualified Data Type UID	Occurrence MIN	Occurrence Max
BBIE	Geographical Coordinate. Altitude. Measure	Altitude	The measure of the altitude that reflects the vertical elevation of an object above a surface for this geographical coordinate (Reference ISO 6709).			0	1
BBIE	Geographical Coordinate. Latitude. Measure	Latitude	The measure of the latitude as an angular distance north or south from the Equator meridian to the meridian of a specific place for this geographical coordinate (Reference ISO 6709).	[6000]		0	1
BBIE	Geographical Coordinate. Longitude. Measure	Longitude	The measure of the longitude as an angular distance east or west from the Greenwich meridian to the meridian of a specific place (Reference ISO 6709).	[6002]		0	1
BBIE	Geographical Coordinate. System. Identifier	System ID	The unique identifier of the reference system used for measuring a geographical coordinate.			0	1
ABIE	Header_ Trade Agreement. Details	Header Trade Agreement	The contractual terms of a header trade agreement.				
BBIE	Header_ Trade Agreement. Buyer_ Reference. Text	Buyer Reference Text	A buyer reference, expressed as text, for this header trade agreement.			0	1
ASBIE	Header_ Trade Agreement. Seller. Trade_ Party	Seller	The seller party for this header trade agreement.			0	1
ASBIE	Header_ Trade Agreement. Buyer. Trade_ Party	Buyer	The buyer party for this header trade agreement.			0	1
ASBIE	Header_ Trade Agreement. Buyer_ Assigned Accountant. Trade_ Party	Buyer Assigned Accountant	The party assigned as an accountant by the buyer for this header trade agreement.			0	1
ASBIE	Header_ Trade Agreement. Seller_ Order. Referenced_ Document	Seller Order Document	The seller generated order document referenced in this header trade agreement.			0	1
ASBIE	Header_ Trade Agreement. Buyer_ Order. Referenced_ Document	Buyer Order Document	The buyer generated order document referenced in this header trade agreement.			0	1

ABIE/ BBIE/ ASBIE	Dictionary Entry Name	Short Name	Definition	TDED	Qualified Data Type UID	Occurrence MIN	Occurrence Max
ASBIE	Header_ Trade Agreement. Marketplace_ Order. Referenced_ Document	Marketplace Order Document	The marketplace generated order document referenced in this header trade agreement.			0	1
ASBIE	Header_ Trade Agreement. Quotation. Referenced_ Document	Quotation Document	The quotation document referenced in this header trade agreement.			0	1
ASBIE	Header_ Trade Agreement. Quotation Request. Referenced_ Document	Quotation Request Document	The quotation request document referenced in this header trade agreement.			0	1
ASBIE	Header_ Trade Agreement. Contract. Referenced_ Document	Contract Document	A contract document referenced in this header trade agreement.			0	unbounded
ASBIE	Header_ Trade Agreement. Requisition. Referenced_ Document	Requisition Document	A requisition document referenced in this header trade agreement.			0	1
ASBIE	Header_ Trade Agreement. Price List. Referenced_ Document	Price List Document	The price list document referenced in this header trade agreement.			0	1
ASBIE	Header_ Trade Agreement. Additional. Referenced_ Document	Additional Document	An additional document referenced in this header trade agreement.			0	unbounded
ASBIE	Header_ Trade Agreement. Sales Report. Referenced_ Document	Sales Report Document	The sales report document referenced in this header trade agreement.			0	1
ASBIE	Header_ Trade Agreement. Blanket Order. Referenced_ Document	Blanket Order Document	The blanket order document referenced in this header trade agreement.			0	1
ASBIE	Header_ Trade Agreement. Previous_ Order. Referenced_ Document	Previous Order Document	The previous order document referenced in this header trade agreement.			0	1
ASBIE	Header_ Trade Agreement. Previous_ Order Change. Referenced_ Document	Previous Order Change Document	The previous order change document referenced in this header trade agreement.			0	1
ASBIE	Header_ Trade Agreement. Previous_ Order Response. Referenced_ Document	Previous Order Response Document	The previous order response document referenced in this header trade agreement.			0	1
ASBIE	Header_ Trade Agreement. Original_ Order. Referenced_ Document	Original Order Document	The original order document referenced in this header trade agreement.			0	1

ABIE/ BBIE/ ASBIE	Dictionary Entry Name	Short Name	Definition	TDED	Qualified Data Type UID	Occurrence MIN	Occurrence Max
ASBIE	Header_ Trade Agreement. Engineering Change. Referenced_ Document	Engineering Change Document	The engineering change document referenced in this header trade agreement.			0	1
ASBIE	Header_ Trade Agreement. Letter Of Credit. Referenced_ Document	Letter Of Credit Document	The letter of credit document referenced in this header trade agreement.			0	1
ASBIE	Header_ Trade Agreement. Import Licence. Referenced_ Document	Import Licence Document	The import licence document referenced in this header trade agreement.			0	1
ASBIE	Header_ Trade Agreement. Export Licence. Referenced_ Document	Export Licence Document	The export licence document referenced in this header trade agreement.			0	1
ASBIE	Header_ Trade Agreement. Specified. Procuring_ Project	Procuring Project	The procuring project specified for this header trade agreement.			0	1
ASBIE	Header_ Trade Agreement. Relevant. Trade_ Party	Relevant Party	A relevant party for this header trade agreement.			0	unbounded
ABIE	Header_ Trade Delivery. Details	Header Trade Delivery	Shipping arrangements and movement of products and or services including despatch and delivery at a header level.				
ASBIE	Header_ Trade Delivery. Ship To. Trade_ Party	Ship To Party	The ship to party, at header level, for this trade delivery.			0	1
ASBIE	Header_ Trade Delivery. Ship From. Trade_ Party	Ship From Party	The ship from party, at header level, for this trade delivery.			0	1
ASBIE	Header_ Trade Delivery. Specified. Delivery_ Instructions	Delivery Instructions	Delivery instructions, at header level, specified for this trade delivery.			0	1
ASBIE	Header_ Trade Delivery. Planned_ Despatch. Supply Chain_ Event	Planned Despatch Event	A despatch event, at header level, planned for this trade delivery.			0	1
ASBIE	Header_ Trade Delivery. Planned_ Release. Supply Chain_ Event	Planned Release Event	The release event, at header level, planned for this trade delivery.			0	1
ASBIE	Header_ Trade Delivery. Planned_ Delivery. Supply Chain_ Event	Planned Delivery Event	A delivery event, at header level, planned for this trade delivery.			0	1

ABIE/ BBIE/ ASBIE	Dictionary Entry Name	Short Name	Definition	TDED	Qualified Data Type UID	Occurrence MIN	Occurrence Max
ASBIE	Header_ Trade Delivery. Planned. Supply Chain_ Consignment	Planned Consignment	A consignment, at header level, planned for this trade delivery.			0	unbounded
ABIE	Header_ Trade Settlement. Details	Header Trade Settlement	The information, at a header level, that enables the reconciliation of a financial transaction, with the item(s) that the financial transaction is intended to settle, such as a commercial invoice.				
BBIE	Header_ Trade Settlement. Due Payable. Amount	Due Payable Amount	A monetary value that is an exact amount due and payable for this header trade settlement, such as the amount due to the creditor.			0	unbounded
BBIE	Header_ Trade Settlement. Tax_ Currency. Code	Tax Currency Code	The code specifying the tax currency for this header trade settlement.	[6345]	UN02000004	0	1
BBIE	Header_ Trade Settlement. Order_ Currency. Code	Order Currency Code	The code specifying the currency of the order for this header trade settlement.	[6345]	UN02000004	0	1
BBIE	Header_ Trade Settlement. Invoice_ Currency. Code	Invoice Currency Code	The code specifying the invoice currency for this header trade settlement.	[6345]	UN02000004	0	1
BBIE	Header_ Trade Settlement. Price_ Currency. Code	Price Currency Code	The code specifying the price currency for this header trade settlement.	[6345]	UN02000004	0	1
ASBIE	Header_ Trade Settlement. Invoicee. Trade_ Party	Invoicee	The party to whom an invoice is issued for this header trade settlement.			0	1
ASBIE	Header_ Trade Settlement. Payer. Trade_ Party	Payer	The payer party for this header trade settlement.			0	1
ASBIE	Header_ Trade Settlement. Tax_ Applicable. Trade_ Currency Exchange	Tax Currency Exchange	A currency exchange applicable to a tax in this header trade settlement.			0	1
ASBIE	Header_ Trade Settlement. Order_ Applicable. Trade_ Currency Exchange	Order Currency Exchange	The currency exchange applicable to the order currency in this header trade settlement.			0	1

ABIE/ BBIE/ ASBIE	Dictionary Entry Name	Short Name	Definition	TDED	Qualified Data Type UID	Occurrence MIN	Occurrence Max
ASBIE	Header_ Trade Settlement. Invoice_ Applicable. Trade_ Currency Exchange	Invoice Currency Exchange	The currency exchange applicable to the invoice in this header trade settlement.			0	1
ASBIE	Header_ Trade Settlement. Price_ Applicable. Trade_ Currency Exchange	Price Currency Exchange	The currency exchange applicable to the price in this header trade settlement.			0	1
ASBIE	Header_ Trade Settlement. Specified. Trade Settlement_ Payment Means	Payment Means	A payment means specified for this header trade settlement.			0	1
ASBIE	Header_ Trade Settlement. Applicable. Trade_ Tax	Trade Tax	A tax applicable to this header trade settlement.			0	unbounded
ASBIE	Header_ Trade Settlement. Specified. Trade_ Allowance Charge	Allowance/Charge	An allowance or charge specified for this header trade settlement.			0	unbounded
ASBIE	Header_ Trade Settlement. Specified. Trade_ Payment Terms	Payment Terms	Payment terms specified for this header trade settlement.			0	1
ASBIE	Header_ Trade Settlement. Specified. Trade Settlement Header_ Monetary Summation	Monetary Summation	The monetary summation totals specified for this header trade settlement.			0	1
ASBIE	Header_ Trade Settlement. Payable_ Specified. Trade_ Accounting Account	Accounts Payable	A payable accounting account specified for this header trade settlement.			0	unbounded
ASBIE	Header_ Trade Settlement. Purchase_ Specified. Trade_ Accounting Account	Purchase Accounting Account	A purchase accounting account specified for this header trade settlement.			0	unbounded
ABIE	Inspection_ Event. Details	Inspection Event	A significant occurrence or happening related to an inspection.				
BBIE	Inspection_ Event. Occurrence. Date Time	Occurrence Date Time	The date, time, date time, or other date time value of the occurrence of this inspection event.	(2193)		#N/B	#N/B
BBIE	Inspection_ Event. Type. Code	Type Code	The code specifying the type of inspection for this event.	(9171)		#N/B	#N/B

ABIE/ BBIE/ ASBIE	Dictionary Entry Name	Short Name	Definition	TDED	Qualified Data Type UID	Occurrence MIN	Occurrence Max
BBIE	Inspection_ Event. Description. Text	Description	A textual description of the inspection for this event.			#N/B	#N/B
ASBIE	Inspection_ Event. Occurrence. Referenced_ Location	Occurrence Referenced Location	The referenced location where this inspection event will occur or has occurred.			#N/B	#N/B
ABIE	Legal_ Organization. Details	Legal Organization	An organization set up on a legal basis as a business, government body, department, charity, or financial institution.				
BBIE	Legal_ Organization. Legal Classification. Code	Legal Classification Code	The code specifying the legal classification of this organization, such as Incorporated (Inc), Limited Liability Corporation (LLC) or non-profit.			0	1
BBIE	Legal_ Organization. Name. Text	Name	A name, expressed as text, of this legally set up organization.			0	1
BBIE	Legal_ Organization. Identification. Identifier	ID	A unique identifier for this legally set up organization.			0	1
BBIE	Legal_ Organization. Trading Business Name. Text	Trading Name	The trading business name, expressed as text, of this legally set up organization.			0	1
ASBIE	Legal_ Organization. Postal. Trade_ Address	Postal Address	A postal address for this legally set up organization.			0	1
ASBIE	Legal_ Organization. Authorized. Legal_ Registration	Authorized Registration	A legal registration authorized for this legally set up organization.			0	unbounded
ABIE	Legal_ Registration. Details	Legal Registration	The recording of items or details for a specific legal purpose.				
BBIE	Legal_ Registration. Type. Code	Type Code	A code specifying the type of this legal registration.			0	1
BBIE	Legal_ Registration. Identification. Identifier	ID	A unique identifier for this legal registration.			0	1
ABIE	Line_ Trade Agreement. Details	Line Trade Agreement	The contractual terms of a line trade agreement.				

ABIE/ BBIE/ ASBIE	Dictionary Entry Name	Short Name	Definition	TDED	Qualified Data Type UID	Occurrence MIN	Occurrence Max
BBIE	Line_ Trade Agreement. Buyer_ Reference. Text	Buyer Reference Text	A buyer reference, expressed as text, for this line trade agreement.			0	1
ASBIE	Line_ Trade Agreement. Seller. Trade_ Party	Seller	The seller party for this line trade agreement.			0	1
ASBIE	Line_ Trade Agreement. Buyer_ Requisitioner. Trade_ Party	Buyer Requisitioner	A party who is a buyer requisitioner in this line trade agreement.			0	1
ASBIE	Line_ Trade Agreement. Applicable. Trade_ Delivery Terms	Trade Delivery Terms	The terms of delivery applicable to this line trade agreement.			0	1
ASBIE	Line_ Trade Agreement. Seller_ Order. Referenced_ Document	Seller Order Document	The seller generated order document referenced in this line trade agreement.			0	1
ASBIE	Line_ Trade Agreement. Buyer_ Order. Referenced_ Document	Buyer Order Document	A buyer generated order document referenced in this line trade agreement.			0	1
ASBIE	Line_ Trade Agreement. Marketplace_ Order. Referenced_ Document	Marketplace Order Document	The marketplace generated order document referenced in this line trade agreement.			0	1
ASBIE	Line_ Trade Agreement. Quotation. Referenced_ Document	Quotation Document	The quotation document referenced in this line trade agreement.			0	1
ASBIE	Line_ Trade Agreement. Quotation Request. Referenced_ Document	Quotation Request Document	The quotation request document referenced in this line trade agreement.			0	1
ASBIE	Line_ Trade Agreement. Contract. Referenced_ Document	Contract Document	A contract document referenced in this line trade agreement.			0	1
ASBIE	Line_ Trade Agreement. Requisition. Referenced_ Document	Requisition Document	A requisition document referenced in this line trade agreement.			0	1
ASBIE	Line_ Trade Agreement. Additional. Referenced_ Document	Additional Document	An additional document referenced in this line trade agreement.			0	unbounded
ASBIE	Line_ Trade Agreement. Gross Price_ Product. Trade_ Price	Product Gross Price	A gross product price in this line trade agreement.			0	1
ASBIE	Line_ Trade Agreement. Net Price_ Product. Trade_ Price	Product Net Price	A net product price in this line trade agreement.			0	1

ABIE/ BBIE/ ASBIE	Dictionary Entry Name	Short Name	Definition	TDED	Qualified Data Type UID	Occurrence MIN	Occurrence Max
ASBIE	Line_ Trade Agreement. Catalogue. Referenced_ Document	Catalogue Document	A catalogue document referenced by this line trade agreement.			0	1
ASBIE	Line_ Trade Agreement. Sales Report. Referenced_ Document	Sales Report Document	The sales report document referenced in this line trade agreement.			0	1
ASBIE	Line_ Trade Agreement. Blanket Order. Referenced_ Document	Blanket Order Document	The blanket order document referenced in this line trade agreement.			0	1
ASBIE	Line_ Trade Agreement. Previous_ Order. Referenced_ Document	Previous Order Document	The previous order document referenced in this line trade agreement.			0	1
ASBIE	Line_ Trade Agreement. Original_ Order. Referenced_ Document	Original Order Document	The original order document referenced in this line trade agreement.			0	1
ASBIE	Line_ Trade Agreement. Engineering Change. Referenced_ Document	Engineering Change Document	The engineering change document referenced in this line trade agreement.			0	1
ASBIE	Line_ Trade Agreement. Letter Of Credit. Referenced_ Document	Letter Of Credit Document	The letter of credit document referenced in this line trade agreement.			0	1
ASBIE	Line_ Trade Agreement. Import Licence. Referenced_ Document	Import Licence Document	The import licence document referenced in this line trade agreement.			0	1
ASBIE	Line_ Trade Agreement. Export Licence. Referenced_ Document	Export Licence Document	The export licence document referenced in this line trade agreement.			0	1
ABIE	Line_ Trade Delivery. Details	Line Trade Delivery	Shipping arrangements and movement of products and or services including despatch and delivery at a line level.				
BBIE	Line_ Trade Delivery. Partial Delivery Allowed. Indicator	Partial Delivery Allowed Indicator	The indication, at line level, of whether or not this trade delivery can be partially delivered.			0	1
BBIE	Line_ Trade Delivery. Requested. Quantity	Requested Quantity	The quantity, at line level, requested for this trade delivery.			0	1
BBIE	Line_ Trade Delivery. Agreed. Quantity	Agreed Quantity	The quantity, at line level, agreed for this trade delivery.			0	1
BBIE	Line_ Trade Delivery. Per Package_ Unit. Quantity	Per Package Unit Quantity	The number of units per package, at line level, in this trade delivery.			0	1

ABIE/ BBIE/ ASBIE	Dictionary Entry Name	Short Name	Definition	TDED	Qualified Data Type UID	Occurrence MIN	Occurrence Max
ASBIE	Line_ Trade Delivery. Projected. Supply Chain_ Supply Plan	Projected Supply Plan	A supply plan, at line level, projected for this trade delivery.			0	1
ASBIE	Line_ Trade Delivery. Ship To. Trade_ Party	Ship To Party	The ship to party, at line level, for this trade delivery.			0	1
ASBIE	Line_ Trade Delivery. Ship From. Trade_ Party	Ship From Party	The ship from party, at line level, for this trade delivery.			0	1
ASBIE	Line_ Trade Delivery. Specified. Delivery_ Instructions	Delivery Instructions	Delivery instructions, at line level, specified for this trade delivery.			0	1
ASBIE	Line_ Trade Delivery. Requested_ Delivery. Supply Chain_ Event	Requested Delivery Event	A delivery event, at line level, requested for this trade delivery.			0	1
ASBIE	Line_ Trade Delivery. Additional. Referenced_ Document	Additional Document	An additional document, at line level, referenced for this trade delivery.			0	unbounded
ASBIE	Line_ Trade Delivery. Planned. Supply Chain_ Consignment	Planned Consignment	A consignment, at line level, planned for this trade delivery.			0	1
ASBIE	Line_ Trade Delivery. Confirmed_ Delivery. Supply Chain_ Event	Confirmed Delivery Event	The confirmed delivery event, at line level, for this trade delivery.			0	1
ABIE	Line_ Trade Settlement. Details	Line Trade Settlement	The information, at a line level, that enables the reconciliation of a financial transaction with the item(s) that the financial transaction is intended to settle, for example a commercial invoice.				
ASBIE	Line_ Trade Settlement. Invoicee. Trade_ Party	Invoicee	The party to whom an invoice is issued for this line trade settlement.			0	1
ASBIE	Line_ Trade Settlement. Payer. Trade_ Party	Payer	The payer party for this line trade settlement.			0	1
ASBIE	Line_ Trade Settlement. Applicable. Trade_ Tax	Trade Tax	A tax applicable to this line trade settlement.			0	unbounded
ASBIE	Line_ Trade Settlement. Specified. Trade_ Allowance Charge	Allowance/Charge	An allowance or charge specified for this line trade settlement.			0	unbounded

ABIE/ BBIE/ ASBIE	Dictionary Entry Name	Short Name	Definition	TDED	Qualified Data Type UID	Occurrence MIN	Occurrence Max
ASBIE	Line_ Trade Settlement. Specified. Trade Settlement Line_ Monetary Summation	Monetary Summation	The monetary summation totals specified for this line trade settlement.			0	1
ABIE	Logistics_ Location. Details	Logistics Location	A logistics related physical location or place.				
BBIE	Logistics_ Location. Identification. Identifier	ID	A unique identifier for this logistics related location, such as a United Nations Location Code (UNLOCODE) or GS1 Global Location Number (GLN).	(3225)		0	1
BBIE	Logistics_ Location. Name. Text	Name	A name, expressed as text, of this logistics related location.	(3224)		0	unbounded
BBIE	Logistics_ Location. Type. Code	Type Code	A code specifying the type of this logistics related location.	(3227)		0	1
BBIE	Logistics_ Location. Description. Text	Description	A textual description of this logistics related location.			0	unbounded
ASBIE	Logistics_ Location. Physical. Geographical Coordinate	Geographical Coordinates	Geographical coordinate information for this logistics related location.			0	1
ASBIE	Logistics_ Location. Postal. Trade_ Address	Postal Address	The postal trade address information for this logistics related location.			0	1
ABIE	Logistics_ Transport Equipment. Details	Logistics Transport Equipment	A piece of equipment used to hold, protect or secure cargo for logistics purposes.				
BBIE	Logistics_ Transport Equipment. Identification. Identifier	ID	The unique identifier of this piece of logistics transport equipment.	(8260)		0	1
BBIE	Logistics_ Transport Equipment. Loading Length. Measure	Loading Length	The measure of the loading length of this piece of logistics transport equipment.	(6411)	UN02000092	0	1
BBIE	Logistics_ Transport Equipment. Category. Code	Category Code	The code specifying the category for this piece of logistics transport equipment, such as container or trailer.	(8053)	UN02000087	0	1

ABIE/ BBIE/ ASBIE	Dictionary Entry Name	Short Name	Definition	TDED	Qualified Data Type UID	Occurrence MIN	Occurrence Max
BBIE	Logistics_ Transport Equipment. Characteristic. Code	Size/Type Code	The code specifying the characteristic or characteristics of this piece of logistics transport equipment, such as the ISO 6346 transport equipment size and type code.	(8155)	UN02000061	0	1
BBIE	Logistics_ Transport Equipment. Used Capacity. Code	Full/Empty Code	The code specifying the used capacity of this piece of logistics transport equipment, such as full or empty.	(8169)	UN02000088	0	1
ASBIE	Logistics_ Transport Equipment. Linear. Spatial_ Dimension	Dimensions	The linear spatial dimensions of this piece of logistics transport equipment.			0	1
ABIE	Logistics_ Transport Means. Details	Logistics Transport Means	The devices used to convey goods or other objects from place to place during logistics cargo movements.				
BBIE	Logistics_ Transport Means. Type. Code	Type Code	The code specifying the type of logistics means of transport (Reference UNECE Recommendation 28).	(8179)	UN02000098	0	1
BBIE	Logistics_ Transport Means. Type. Text	Type Text	The type, expressed as text, of this logistics means of transport.	(8178)		0	1
BBIE	Logistics_ Transport Means. Identification. Identifier	ID	An identifier of this logistics means of transport, such as the International Maritime Organization number of a vessel.	(8213)		0	1
BBIE	Logistics_ Transport Means. Name. Text	Name	The name, expressed as text, of this logistics means of transport.	(8212)		0	1
ASBIE	Logistics_ Transport Means. Owner. Trade_ Party	Owner	The party owning this logistics means of transport.			0	1
ABIE	Logistics_ Transport Movement. Details	Logistics Transport Movement	The conveyance (physical carriage) of goods or other objects used for logistics transport purposes.				
BBIE	Logistics_ Transport Movement. Stage. Code	Stage Code	The code specifying the stage of this logistics transport movement.	(8051)	UN02000091	0	1

ABIE/ BBIE/ ASBIE	Dictionary Entry Name	Short Name	Definition	TDED	Qualified Data Type UID	Occurrence MIN	Occurrence Max
BBIE	Logistics_ Transport Movement. Mode. Code	Mode Code	The code specifying the mode, such as by air, sea, rail, road or inland waterway, for this logistics transport movement.	(8067)	UN02000018	0	1
BBIE	Logistics_ Transport Movement. Mode. Text	Mode Text	The mode, expressed as text, of this logistics transport movement.	(8066)		0	1
ASBIE	Logistics_ Transport Movement. Used. Logistics_ Transport Means	Used Transport Means	The means of transport used for this logistics transport movement.			0	1
ABIE	Material_ Goods Characteristic. Details	Material Goods Characteristic	A distinctive feature of a material contained within physical goods.				
BBIE	Material_ Goods Characteristic. Description. Text	Description	A textual description of this material goods characteristic.			0	unbounded
BBIE	Material_ Goods Characteristic. Type. Code	Type Code	The code specifying the type of material goods characteristic.			0	1
BBIE	Material_ Goods Characteristic. Proportional_ Constituent. Percent	Constituent Percent	The percentage presence of the material within the goods for this material goods characteristic.			0	1
BBIE	Material_ Goods Characteristic. Absolute Presence_ Weight. Measure	Absolute Presence Weight	The weight measure of the absolute presence of this material goods characteristic.			0	1
BBIE	Material_ Goods Characteristic. Absolute Presence_ Volume. Measure	Absolute Presence Volume	The volume measure of the absolute presence of this material goods characteristic.			0	1
ABIE	Note. Details	Note	A textual or coded description, such as a remark or additional information.				
BBIE	Note. Subject. Text	Subject Text	The subject, expressed as text, of this note.			0	1
BBIE	Note. Content. Code	Content Code	A code specifying the content of this note.	(4441)		0	1
BBIE	Note. Content. Text	Content Text	A content, expressed as text, of this note.	(4440)		0	unbounded

ABIE/ BBIE/ ASBIE	Dictionary Entry Name	Short Name	Definition	TDED	Qualified Data Type UID	Occurrence MIN	Occurrence Max
BBIE	Note. Subject. Code	Subject Code	The code specifying the subject of this note.	(4451)		0	1
BBIE	Note. Identification. Identifier	ID	A unique identifier for this note.			0	1
ABIE	Procuring_ Project. Details	Procuring Project	An endeavour carefully planned to achieve a procurement of goods, works and service.				
BBIE	Procuring_ Project. Identification. Identifier	ID	The unique identifier of this procuring project.			1	1
BBIE	Procuring_ Project. Description. Text	Description	The textual description of this procuring project.			0	1
BBIE	Procuring_ Project. Name. Text	Name	The name, expressed as text, of this procuring project.			1	1
BBIE	Procuring_ Project. Works Type. Code	Works Type Code	A code specifying the type of work, such as surveying or consulting, for this procuring project.			#N/B	#N/B
BBIE	Procuring_ Project. Sub_ Works Type. Code	Sub-Works Type Code	A code specifying the type of sub works, such as land surveying or information technology consulting, for this procuring project.			#N/B	#N/B
BBIE	Procuring_ Project. Type. Code	Type Code	The code specifying the type of procuring project, such as goods, works and service.			#N/B	#N/B
BBIE	Procuring_ Project. Constraint. Indicator	Constraint Indicator	The indication of whether or not the project is constrained by an authority such as the World Trade Organization (WTO) for this procuring project.			#N/B	#N/B
BBIE	Procuring_ Project. Total_ Budget. Amount	Total Budget Amount	The monetary value of the total budget which includes net amount, taxes, and material and instalment costs for this procuring project.			#N/B	#N/B
BBIE	Procuring_ Project. Net_ Budget. Amount	Net Budget Amount	The monetary value of the net budget for this procuring project.			#N/B	#N/B

ABIE/ BBIE/ ASBIE	Dictionary Entry Name	Short Name	Definition	TDED	Qualified Data Type UID	Occurrence MIN	Occurrence Max
ABIE	Product Characteristic_ Condition. Details	Product Characteristic Condition	A state that applies to a product characteristic.			#N/B	#N/B
BBIE	Product Characteristic_ Condition. Type. Code	Type Code	The code specifying the type of product characteristic condition.			0	1
BBIE	Product Characteristic_ Condition. Name. Text	Name	A name, expressed as text, for this product characteristic condition.			0	unbounded
BBIE	Product Characteristic_ Condition. Value. Measure	Value	The measure of the value for this product characteristic condition.			0	1
ABIE	Product_ Characteristic. Details	Product Characteristic	A prominent attribute or aspect of a product.			#N/B	#N/B
BBIE	Product_ Characteristic. Identification. Identifier	ID	A unique identifier for this product characteristic.			0	unbounded
BBIE	Product_ Characteristic. Type. Code	Type Code	A code specifying a type of product characteristic.			0	1
BBIE	Product_ Characteristic. Description. Text	Description	A textual description of this product characteristic.	(7036)		0	unbounded
BBIE	Product_ Characteristic. Value. Measure	Value Measure	A measure of a value for this product characteristic.			0	1
BBIE	Product_ Characteristic. Measurement Method. Code	Measurement Method Code	A code specifying a measurement method for this product characteristic.			0	1
BBIE	Product_ Characteristic. Value. Text	Value Text	A value, expressed as text, for this product characteristic.	(7110)		0	unbounded
BBIE	Product_ Characteristic. Value. Code	Value Code	The code specifying the value of this product characteristic.	(7111)		0	1
BBIE	Product_ Characteristic. Value. Date Time	Value Date Time	The value for this product characteristic expressed as a date, time, date time, or other date time value.			0	1
BBIE	Product_ Characteristic. Value. Indicator	Value Indicator	The value for this product characteristic expressed as an indicator.			0	1
BBIE	Product_ Characteristic. Content_ Type. Code	Content Type Code	A code specifying the content type of this product characteristic.			0	1

ABIE/ BBIE/ ASBIE	Dictionary Entry Name	Short Name	Definition	TDED	Qualified Data Type UID	Occurrence MIN	Occurrence Max
ASBIE	Product_ Characteristic. Value. Specified_ Binary File	Value Binary File	The value for this product characteristic expressed in a binary file.			0	1
ASBIE	Product_ Characteristic. Applicable. Product Characteristic_ Condition	Applicable Condition	A condition applicable to this product characteristic.			0	unbounded
ASBIE	Product_ Characteristic. Applicable. Referenced_ Standard	Applicable Referenced Standard	The referenced standard that is applicable to this product characteristic.			0	1
ABIE	Product_ Classification. Details	Product Classification	A systematic arrangement of products in classes or categories according to established criteria.			#N/B	#N/B
BBIE	Product_ Classification. System. Identifier	System ID	The unique identifier of the classification system for this product classification.	(9019)		0	1
BBIE	Product_ Classification. System Name. Text	System Name	A name, expressed as text, of the classification system for this product classification.	(9018)		0	unbounded
BBIE	Product_ Classification. Class. Code	Class Code	The code specifying the class for this product classification.	(9021)		0	1
BBIE	Product_ Classification. Class Name. Text	Class Name	A class name, expressed as text, for this product classification.	(9020)		0	unbounded
BBIE	Product_ Classification. Sub_ Class. Code	Sub-Class Code	The code specifying the sub class for this product classification.			0	1
ASBIE	Product_ Classification. Class. Product_ Characteristic	Product Class Characteristic	A product class characteristic for this product classification.			0	unbounded
ASBIE	Product_ Classification. Applicable. Referenced_ Standard	Applicable Referenced Standard	The referenced standard that is applicable to this product classification.			0	1
ABIE	Referenced_ Document. Details	Referenced Document	Written, printed or electronic matter that is referenced.			#N/B	#N/B
BBIE	Referenced_ Document. Issuer Assigned_ Identification. Identifier	Issuer Assigned ID	The unique issuer assigned identifier for this referenced document.	(1004)		0	1
BBIE	Referenced_ Document. URI Identification. Identifier	URI	The unique Uniform Resource Identifier (URI) for this referenced document.	(1004)		0	1

ABIE/ BBIE/ ASBIE	Dictionary Entry Name	Short Name	Definition	TDED	Qualified Data Type UID	Occurrence MIN	Occurrence Max
BBIE	Referenced_ Document. Status. Code	Status Code	The code specifying the status for this referenced document.	(1373)	UN02000025	0	1
BBIE	Referenced_ Document. Copy. Indicator	Copy Indicator	The indication of whether or not the referenced document is a copy.			0	1
BBIE	Referenced_ Document. Line. Identifier	Line ID	The unique identifier of a line in this referenced document.	(1156)		0	1
BBIE	Referenced_ Document. Type. Code	Type Code	The code specifying the type of referenced document.	(1001)	UN02000006	0	1
BBIE	Referenced_ Document. Global_ Identification. Identifier	Global ID	A unique global identifier for this referenced document.	(1004)		0	1
BBIE	Referenced_ Document. Revision_ Identification. Identifier	Revision ID	A unique identifier for a revision of this referenced document.	(1004)		0	1
BBIE	Referenced_ Document. Name. Text	Name	A name, expressed as text, for this referenced document.	(1000)		0	unbounded
BBIE	Referenced_ Document. Attachment. Binary Object	Attached Binary Object	A binary object that is attached or otherwise appended to this referenced document.			0	unbounded
BBIE	Referenced_ Document. Information. Text	Information	Information, expressed as text, for this referenced document.	(4142)		0	unbounded
BBIE	Referenced_ Document. Reference_ Type. Code	Reference Type Code	The code specifying the reference type of this referenced document.	(1153)	UN02000048	0	1
BBIE	Referenced_ Document. Section Name. Text	Section Name	A section name, expressed as text, for this referenced document.			0	unbounded
BBIE	Referenced_ Document. Previous Revision_ Identification. Identifier	Previous Revision ID	An identifier for a previous revision of this referenced document.	(1004)		0	unbounded
BBIE	Referenced_ Document. Formatted_ Issue. Date Time	Formatted Issue Date Time	The formatted date or date time for the issuance of this referenced document.	(2379)	UN02000153	0	1
ASBIE	Referenced_ Document. Effective. Specified_ Period	Effective Period	The specified period within which this referenced document is effective.			0	1

ABIE/ BBIE/ ASBIE	Dictionary Entry Name	Short Name	Definition	TDED	Qualified Data Type UID	Occurrence MIN	Occurrence Max
ASBIE	Referenced_ Document. Issuer. Trade_ Party	Issuer	The trade related party that issues this referenced document.			0	1
ASBIE	Referenced_ Document. Attached. Specified_ Binary File	Attached Binary File	A specified binary file attached to this referenced document.			0	unbounded
BBIE	Referenced_ Logistics_ Package. Item. Quantity	Item Quantity	The number of referenced logistics packages at this level.	(7224)		0	1
BBIE	Referenced_ Logistics_ Package. Level. Code	Level Code	The code specifying the level of this referenced logistics package.	(7075)	UN02000078	0	1
BBIE	Referenced_ Logistics_ Package. Type. Code	Type Code	The code specifying the type of referenced logistics package.	(7065)	UN02000043	0	1
BBIE	Referenced_ Logistics_ Package. Sequence. Numeric	Sequence Number	The sequence number of this referenced logistics package.	(7070)		0	1
BBIE	Referenced_ Logistics_ Package. Identification. Identifier	ID	The identifier for this referenced logistics package.	(1438)		0	1
BBIE	Referenced_ Logistics_ Package. Global_ Identification. Identifier	Global ID	The global identifier for this referenced logistics package.	(1438)		0	1
BBIE	Referenced_ Logistics_ Package. Parent_ Identification. Identifier	Parent ID	The parent identifier for this referenced logistics package.	(1438)		0	1
BBIE	Referenced_ Logistics_ Package. Series Start_ Identification. Identifier	Series Start ID	The identifier of the start of a series of packages within this referenced logistics package.	(1438)		0	1
BBIE	Referenced_ Logistics_ Package. Series End_ Identification. Identifier	Series End ID	The identifier of the end of a series of packages within this referenced logistics package.	(1438)		0	1
ABIE	Referenced_ Product. Details	Referenced Product	A reference to a product or service produced by human or mechanical effort or by a natural process for trading purposes.			#N/B	#N/B
BBIE	Referenced_ Product. Identification. Identifier	ID	A unique identifier for this referenced product.	(7135)		0	unbounded

ABIE/ BBIE/ ASBIE	Dictionary Entry Name	Short Name	Definition	TDED	Qualified Data Type UID	Occurrence MIN	Occurrence Max
BBIE	Referenced_ Product. Global_ Identification. Identifier	Global ID	A unique global identifier for this referenced product.	(7135)		0	unbounded
BBIE	Referenced_ Product. Seller Assigned_ Identification. Identifier	Seller Assigned ID	The unique seller assigned identifier for this referenced product.	(7135)		0	1
BBIE	Referenced_ Product. Buyer Assigned_ Identification. Identifier	Buyer Assigned ID	The unique buyer assigned identifier for this referenced product.	(7135)		0	1
BBIE	Referenced_ Product. Manufacturer Assigned_ Identification. Identifier	Manufacturer Assigned ID	A unique manufacturer assigned identifier for this referenced product.	(7135)		0	1
BBIE	Referenced_ Product. Industry Assigned_ Identification. Identifier	Industry Assigned ID	A unique industry assigned identifier for this referenced product.	(7135)		0	1
BBIE	Referenced_ Product. Description. Text	Description	A textual description for this referenced product.			0	unbounded
BBIE	Referenced_ Product. Relationship_ Type. Code	Relationship Type Code	A code specifying a type of relationship for this referenced product.			0	unbounded
BBIE	Referenced_ Product. Unit. Quantity	Unit Quantity	A unit quantity of this referenced product.			0	unbounded
ABIE	Referenced_ Standard. Details	Referenced Standard	A referenced norm or requirement that establishes uniform criteria, methods, processes and practices, such as in engineering or technical areas.			#N/B	#N/B
BBIE	Referenced_ Standard. Identification. Identifier	ID	The identifier of this referenced standard.			0	1
BBIE	Referenced_ Standard. Version. Identifier	Version ID	The identifier of the version of this referenced standard.			0	1
BBIE	Referenced_ Standard. Element Version. Identifier	Element Version ID	The identifier of the version of a specific element within the referenced standard, such as the version of a data element.			0	1
BBIE	Referenced_ Standard. URI. Identifier	URI	The Uniform Resource Identifier (URI) for this referenced standard.			0	1
BBIE	Referenced_ Standard. Part_ Identification. Identifier	Part ID	The identifier of a part of this referenced standard, such as a section or topic.			0	1

ABIE/ BBIE/ ASBIE	Dictionary Entry Name	Short Name	Definition	TDED	Qualified Data Type UID	Occurrence MIN	Occurrence Max
BBIE	Referenced_ Standard. Agency. Identifier	Agency ID	The identifier of the agency for this referenced standard.			0	1
ABIE	Reference_ Price. Details	Reference Price	A reference to a sum of money for which something is or may be bought or sold.			#N/B	#N/B
BBIE	Reference_ Price. Charge. Amount	Charge Amount	The monetary value of a charged reference price.			0	1
BBIE	Reference_ Price. Basis. Quantity	Basis Quantity	A quantity on which the reference price is based.	(5310)		0	unbounded
BBIE	Reference_ Price. Net Price. Indicator	Net Price Indicator	An indication of whether or not the reference price is a net price.			0	unbounded
BBIE	Reference_ Price. Comparison Method. Code	Comparison Method Code	The code specifying the comparison method for this reference price.			0	1
ABIE	Registered_ Tax. Details	Registered Tax	A registered tax or duty system pertaining to an authority.			#N/B	#N/B
BBIE	Registered_ Tax. Type. Code	Type Code	The code specifying the type of registered tax.	(5153)		0	1
BBIE	Registered_ Tax. Exemption Reason. Code	Exemption Reason Code	The code specifying the exemption reason for this registered tax.			0	1
BBIE	Registered_ Tax. Exemption Reason. Text	Exemption Reason Text	A reason, expressed as text, for exemption from this registered tax.			0	unbounded
BBIE	Registered_ Tax. Currency. Code	Currency Code	The code specifying the currency for this registered tax.			0	1
BBIE	Registered_ Tax. Jurisdiction. Text	Jurisdiction Text	A jurisdiction, expressed as text, for this registered tax.			0	unbounded
BBIE	Registered_ Tax. Description. Text	Description	A textual description of this registered tax.			0	unbounded
BBIE	Registered_ Tax. Customs Duty. Indicator	Customs Duty Indicator	The indication of whether or not this registered tax is a customs duty.			0	1

ABIE/ BBIE/ ASBIE	Dictionary Entry Name	Short Name	Definition	TDED	Qualified Data Type UID	Occurrence MIN	Occurrence Max
ABIE	Spatial_ Dimension. Details	Spatial Dimensions	A measure of spatial extent of an object, such as the length, breadth or height of a shipping container.			#N/B	#N/B
BBIE	Spatial_ Dimension. Value. Measure	Value Measure	The measure of the value of this spatial dimension.			0	1
BBIE	Spatial_ Dimension. Type. Code	Type Code	The code specifying the type of spatial dimension, such as thickness, area, or volume.	(6145)	UN02000071	0	1
BBIE	Spatial_ Dimension. Description. Text	Description	A textual description of this spatial dimension.			0	unbounded
BBIE	Spatial_ Dimension. Width. Measure	Width	The measure of the width component of this spatial dimension.			0	1
BBIE	Spatial_ Dimension. Length. Measure	Length	The measure of the length component of this spatial dimension.			0	1
BBIE	Spatial_ Dimension. Height. Measure	Height	The measure of the height component of this spatial dimension.			0	1
BBIE	Spatial_ Dimension. Identification. Identifier	ID	The unique identifier of this spatial dimension.			0	1
BBIE	Spatial_ Dimension. Diameter. Measure	Diameter	The measure of the diameter component for this spatial dimension.	(6411)	UN02000092	0	1
ABIE	Specified_ Binary File. Details	Binary File	A specified computer file or program stored in a binary format.			#N/B	#N/B
BBIE	Specified_ Binary File. Identification. Identifier	ID	A unique identifier for this specified binary file.			0	unbounded
BBIE	Specified_ Binary File. Title. Text	Title	A title, expressed as text, for this specified binary file.			0	unbounded
BBIE	Specified_ Binary File. Author Name. Text	Author Name	A name of an author, expressed as text, of this specified binary file.			0	unbounded
BBIE	Specified_ Binary File. Version. Identifier	Version ID	The unique version identifier for this specified binary file.			0	1

ABIE/ BBIE/ ASBIE	Dictionary Entry Name	Short Name	Definition	TDED	Qualified Data Type UID	Occurrence MIN	Occurrence Max
BBIE	Specified_ Binary File. File Name. Text	Name	The file name, expressed as text, of this specified binary file.			0	1
BBIE	Specified_ Binary File. URI. Identifier	URI	The unique Uniform Resource Identifier (URI) for this specified binary file.			0	1
BBIE	Specified_ Binary File. MIME. Code	MIME Code	The code specifying the Multipurpose Internet Mail Extensions (MIME) type for this specified binary file.			0	1
BBIE	Specified_ Binary File. Encoding. Code	Encoding Code	The code specifying the encoding of this specified binary file.			0	1
BBIE	Specified_ Binary File. Character Set. Code	Character Set Code	The code specifying the character set for this specified binary file.			0	1
BBIE	Specified_ Binary File. Included. Binary Object	Included Binary Object	A binary object included in this specified binary file.			0	unbounded
BBIE	Specified_ Binary File. Access. Text	Access Text	Access information, expressed as text, for this specified binary file, such as security and download parameters.			0	unbounded
BBIE	Specified_ Binary File. Description. Text	Description	A textual description of this specified binary file.			0	unbounded
BBIE	Specified_ Binary File. Size. Measure	Size	The measure of the size of this specified binary file.			0	1
ASBIE	Specified_ Binary File. Access Availability. Specified_ Period	Access Availability Period	The specified period when access to this binary file is available.			0	1
ABIE	Specified_ Period. Details	Period	A specified period of time.			#N/B	#N/B
BBIE	Specified_ Period. Duration. Measure	Duration Measure	A measure of the length of time for this specified time period such as hours, days, weeks, months, years.			0	unbounded
BBIE	Specified_ Period. Inclusive. Indicator	Inclusive Indicator	The indication of whether or not the start and end dates are included in this specified period.			0	1
BBIE	Specified_ Period. Description. Text	Description	A textual description of this specified period of time.	(2118)		0	unbounded

ABIE/ BBIE/ ASBIE	Dictionary Entry Name	Short Name	Definition	TDED	Qualified Data Type UID	Occurrence MIN	Occurrence Max
BBIE	Specified_Period. Start. Date Time	Start Date Time	The date, time, date time or other date time value for the start of this specified period of time.			0	1
BBIE	Specified_Period. End. Date Time	End Date Time	The date, time, date time or other date time value for the end of this specified period of time.			0	1
BBIE	Specified_Period. Complete. Date Time	Complete Date Time	The date, time, date time or other date time value for a complete specified period of time expressed as a specific month, a specific week, etc.			0	1
BBIE	Specified_Period. Open. Indicator	Open Indicator	The indication of whether or not an entity is open during this specified period.			0	1
BBIE	Specified_Period. Season. Code	Season Code	The code specifying the season for this specified period.			0	1
BBIE	Specified_Period. Identification. Identifier	ID	The unique identifier of this specified period.			0	1
BBIE	Specified_Period. Name. Text	Name	A name, expressed as text, of this specified period.			0	unbounded
BBIE	Specified_Period. Sequence. Numeric	Sequence Number	A sequence number for this specified period.			0	1
BBIE	Specified_Period. Start Date Flexibility. Code	Start Date Flexibility Code	The code specifying the flexibility of the start date of this specified period.			0	1
BBIE	Specified_Period. Continuous. Indicator	Continuous Indicator	The indication of whether or not this specified period is continuous.			0	1
BBIE	Specified_Period. Purpose. Code	Purpose Code	The code specifying the purpose of this specified period.			0	1
ABIE	Supply Chain_ Consignment Item. Details	Supply Chain Consignment Item	An item within a supply chain consignment of goods separately identified for transport and customs purposes.			#N/B	#N/B

ABIE/ BBIE/ ASBIE	Dictionary Entry Name	Short Name	Definition	TDED	Qualified Data Type UID	Occurrence MIN	Occurrence Max
BBIE	Supply Chain_ Consignment Item. Type. Code	Goods Type Code	The code specifying the type of supply chain consignment item.	(7357)	UN02000058	0	1
BBIE	Supply Chain_ Consignment Item. Type Extension. Code	Goods Type Extension Code	The code used as an extension to the type code for further specifying the type of supply chain consignment item.	(7361)	UN02000057	0	1
BBIE	Supply Chain_ Consignment Item. Declared Value For Customs. Amount	Declared Value For Customs Amount	The monetary value of this supply chain consignment item as declared for customs purposes.	(5032)		0	1
BBIE	Supply Chain_ Consignment Item. Declared Value For Statistics. Amount	Declared Value For Statistics Amount	The monetary value of this supply chain consignment item as declared for statistical purposes.	(5218)		0	1
BBIE	Supply Chain_ Consignment Item. Invoice. Amount	Invoice Amount	A monetary value for an invoice for this supply chain consignment item.	(5444)		0	unbounded
BBIE	Supply Chain_ Consignment Item. Gross Weight. Measure	Gross Weight	A measure of the gross weight (mass) of this supply chain consignment item which includes packaging but excludes any transport equipment.	(6292)	UN02000095	0	1
BBIE	Supply Chain_ Consignment Item. Net Weight. Measure	Net Weight	A measure of the net weight (mass) of this supply chain consignment item which excludes all packaging.	(6016)		0	1
BBIE	Supply Chain_ Consignment Item. Tariff. Quantity	Tariff Quantity	The tariff quantity in this supply chain consignment item.			0	1
ASBIE	Supply Chain_ Consignment Item. Nature Identification. Transport_ Cargo	Cargo Nature Identification	Transport cargo details of this supply chain consignment item sufficient to identify its nature for customs, statistical or transport purposes.			0	1
ABIE	Supply Chain_ Consignment. Details	Supply Chain Consignment	A separately identifiable collection of goods items to be transported or available to be transported from one consignor to one consignee in a supply chain via one or more modes of transport where each consignment is			#N/B	#N/B

ABIE/ BBIE/ ASBIE	Dictionary Entry Name	Short Name	Definition	TDED	Qualified Data Type UID	Occurrence MIN	Occurrence Max
			the subject of one single transport contract.				
BBIE	Supply Chain_ Consignment. Gross Weight. Measure	Gross Weight	A measure of the gross weight (mass) of this supply chain consignment which includes the weight of packaging but which excludes the weight of any transport equipment.	(6012)	UN02000095	0	unbounded
BBIE	Supply Chain_ Consignment. Net Weight. Measure	Net Weight	A measure of the net weight (mass) of this consignment which excludes the weight of packaging of this supply chain consignment and that of any transport equipment.	(6014)		0	unbounded
BBIE	Supply Chain_ Consignment. Gross Volume. Measure	Gross Volume	A measure of the gross volume, normally calculated by multiplying the maximum length, width and height of this supply chain consignment.	(6422)	UN02000094	0	unbounded
BBIE	Supply Chain_ Consignment. Associated Invoice. Amount	Associated Invoice Amount	A monetary value of an invoice associated with this supply chain consignment.	(5444)		0	unbounded
BBIE	Supply Chain_ Consignment. Total Charge. Amount	Total Charge Amount	The total monetary value of all freight and other service charges for this supply chain consignment.	(5290)		0	1
BBIE	Supply Chain_ Consignment. Declared Value For Customs. Amount	Declared Value For Customs Amount	The monetary value declared for customs purposes for this supply chain consignment.	(5032)		0	1
BBIE	Supply Chain_ Consignment. Package. Quantity	Number Of Packages	The number of packages within this supply chain consignment.	(7370)		0	1
ASBIE	Supply Chain_ Consignment. Consignor. Trade_ Party	Consignor	The consignor party for this supply chain consignment.			0	1

ABIE/ BBIE/ ASBIE	Dictionary Entry Name	Short Name	Definition	TDED	Qualified Data Type UID	Occurrence MIN	Occurrence Max
ASBIE	Supply Chain_ Consignment. Consignee. Trade_ Party	Consignee	The consignee party for this supply chain consignment.			0	1
ASBIE	Supply Chain_ Consignment. Carrier. Trade_ Party	Carrier	The carrier party for this supply chain consignment.			0	1
ASBIE	Supply Chain_ Consignment. Freight Forwarder. Trade_ Party	Freight Forwarder	The freight forwarder party for this supply chain consignment.			0	1
ASBIE	Supply Chain_ Consignment. Delivery. Trade_ Party	Delivery Party	The party to whom this supply chain consignment will be, or has been, delivered.			0	1
ASBIE	Supply Chain_ Consignment. Customs Import Agent. Trade_ Party	Customs Import Agent	The party acting as an agent for, or on behalf of, the consignee with respect to the customs import procedures for this supply chain consignment.			0	1
ASBIE	Supply Chain_ Consignment. Customs Export Agent. Trade_ Party	Customs Export Agent	The party acting as an agent for, or on behalf of, the consignor with respect to the customs export procedures for this supply chain consignment.			0	1
ASBIE	Supply Chain_ Consignment. Grouping Centre. Trade_ Party	Grouping Centre	A grouping centre party for this supply chain consignment.			0	unbounded
ASBIE	Supply Chain_ Consignment. Transport Contract. Referenced_ Document	Transport Contract Document	The referenced transport contract document for this supply chain consignment, such as an airwaybill or a seawaybill.			0	1
ASBIE	Supply Chain_ Consignment. Associated. Referenced_ Document	Associated Document	A referenced document associated with this supply chain consignment, such as the certificate of origin or dangerous goods note.			0	unbounded
ASBIE	Supply Chain_ Consignment. Included. Supply Chain_ Consignment Item	Included Consignment Item	A consignment item included in this supply chain consignment.			0	unbounded
ASBIE	Supply Chain_ Consignment. Utilized. Logistics_ Transport Equipment	Used Transport Equipment	Logistics transport equipment utilized for this supply chain consignment.			0	unbounded

ABIE/ BBIE/ ASBIE	Dictionary Entry Name	Short Name	Definition	TDED	Qualified Data Type UID	Occurrence MIN	Occurrence Max
ASBIE	Supply Chain_ Consignment. Specified. Logistics_ Transport Movement	Specified Transport Movement	A logistics transport movement specified for this supply chain consignment.			0	unbounded
ABIE	Supply Chain_ Event. Details	Supply Chain Event	A significant occurrence or happening in a supply chain.			#N/B	#N/B
BBIE	Supply Chain_ Event. Identification. Identifier	ID	The unique identifier for this supply chain event.	(1007)		0	1
BBIE	Supply Chain_ Event. Occurrence. Date Time	Occurrence Date Time	A date, time, date time, or other date time value of an occurrence of this supply chain event.	(2193)		0	1
BBIE	Supply Chain_ Event. Type. Code	Type Code	A code specifying the type of supply chain event.	(9171)		0	1
BBIE	Supply Chain_ Event. Description. Text	Description	A textual description of this supply chain event.			0	unbounded
BBIE	Supply Chain_ Event. Description. Binary Object	Description Binary Object	Binary object data, such as a photograph, describing this supply chain event.			0	unbounded
BBIE	Supply Chain_ Event. Unit. Quantity	Unit Quantity	A number of units for this supply chain event.			0	1
BBIE	Supply Chain_ Event. Latest_ Occurrence. Date Time	Latest Occurrence Date Time	The date, time, date time, or other date time value of the latest occurrence of this supply chain event.	(2193)		0	1
BBIE	Supply Chain_ Event. Earliest_ Occurrence. Date Time	Earliest Occurrence Date Time	The date, time, date time, or other date time value of the earliest occurrence of this supply chain event.	(2193)		0	1
BBIE	Supply Chain_ Event. Time_ Occurrence. Date Time	Occurrence Time	The time value of the occurrence of this supply chain event.	(2193)	UN02000183	0	1
ASBIE	Supply Chain_ Event. Occurrence. Specified_ Period	Occurrence Period	A specified period of time during which this supply chain event occurs.			0	1
ASBIE	Supply Chain_ Event. Occurrence. Logistics_ Location	Location	A logistics location where this supply chain event occurs.			0	1

ABIE/ BBIE/ ASBIE	Dictionary Entry Name	Short Name	Definition	TDED	Qualified Data Type UID	Occurrence MIN	Occurrence Max
ABIE	Supply Chain_ Supply Plan. Details	Supply Chain Supply Plan	Specification of the delivery time and quantity bucket in a supply chain demand forecast or delivery schedule.			#N/B	#N/B
BBIE	Supply Chain_ Supply Plan. Commitment Level. Code	Commitment Level Code	The code specifying the commitment level for this supply chain supply plan, such as fabrication or raw material.	(4017)		0	1
BBIE	Supply Chain_ Supply Plan. Planned. Quantity	Planned Quantity	The planned quantity in this supply chain supply plan.			0	1
BBIE	Supply Chain_ Supply Plan. Actual. Quantity	Actual Quantity	The actual quantity in this supply chain supply plan.			0	1
BBIE	Supply Chain_ Supply Plan. Tolerance. Quantity	Tolerance Quantity	The quantity of tolerance from the planned quantity in this supply chain supply plan.			0	1
BBIE	Supply Chain_ Supply Plan. Synchronization. Date Time	Synchronization Date Time	A date, time, date time, or other date time value of a synchronization of the supply chain supply plan.			0	1
BBIE	Supply Chain_ Supply Plan. Synchronization. Quantity	Synchronization Quantity	The value specifying the quantity for a synchronization of this supply chain supply plan.			0	1
BBIE	Supply Chain_ Supply Plan. Minus_ Tolerance. Quantity	Minus Tolerance Quantity	The minus tolerance quantity from the planned or requested quantity in this supply chain supply plan.			0	1
BBIE	Supply Chain_ Supply Plan. Plus_ Tolerance. Quantity	Plus Tolerance Quantity	The plus tolerance quantity from the planned or requested quantity in this supply chain supply plan.			0	1
ASBIE	Supply Chain_ Supply Plan. Delivery. Supply Chain_ Event	Delivery Event	A delivery event for this supply chain supply plan.			0	unbounded
ASBIE	Supply Chain_ Supply Plan. Specified. Logistics_ Location	Location	A location specified for this supply chain supply plan.			0	unbounded
ASBIE	Supply Chain_ Supply Plan. Scheduled_ Delivery. Supply Chain_ Event	Scheduled Delivery Event	A scheduled delivery event in this supply chain supply plan.			0	unbounded

ABIE/ BBIE/ ASBIE	Dictionary Entry Name	Short Name	Definition	TDED	Qualified Data Type UID	Occurrence MIN	Occurrence Max
ASBIE	Supply Chain_ Supply Plan. Confirmed_ Delivery. Supply Chain_ Event	Confirmed Delivery Event	A confirmed delivery event in this supply chain supply plan.			0	unbounded
ASBIE	Supply Chain_ Supply Plan. Ship To. Trade_ Party	Ship To Party	The ship to trade party for this supply chain supply plan.			0	1
ASBIE	Supply Chain_ Supply Plan. Applicable. Specified_ Period	Applicable Period	The period applicable for this supply chain supply plan.			0	1
ASBIE	Supply Chain_ Supply Plan. Contract. Referenced_ Document	Contract Document	A referenced contract document for this supply chain supply plan.			0	unbounded
ASBIE	Supply Chain_ Supply Plan. Delivery Note. Referenced_ Document	Delivery Note Document	A delivery note document referenced by this supply chain supply plan.			0	unbounded
ABIE	Supply Chain_ Trade Line Item. Details	Supply Chain Trade Line Item	A collection of information specific to an item being used or reported on for supply chain trade purposes.			#N/B	#N/B
ASBIE	Supply Chain_ Trade Line Item. Associated. Document Line_ Document	Associated Document Line	The document line associated with this trade line item.			1	1
ASBIE	Supply Chain_ Trade Line Item. Specified. Trade_ Product	Trade Product	The product specified for this supply chain trade line item.			0	1
ASBIE	Supply Chain_ Trade Line Item. Substituted. Referenced_ Product	Substituted Product	The referenced product substituted for this supply chain trade line item.			0	1
ASBIE	Supply Chain_ Trade Line Item. Specified. Line_ Trade Agreement	Line Trade Agreement	The line trade agreement specified for this supply chain trade line item.			0	1
ASBIE	Supply Chain_ Trade Line Item. Specified. Line_ Trade Delivery	Line Trade Delivery	The line trade delivery specified for this supply chain trade line item.			0	1
ASBIE	Supply Chain_ Trade Line Item. Specified. Line_ Trade Settlement	Line Trade Settlement	A line trade settlement specified for this supply chain trade line item.			0	1
ASBIE	Supply Chain_ Trade Line Item. Physical. Referenced_ Logistics_ Package	Referenced Logistics Package	A physical logistics package referenced for this supply chain trade line item.			0	1

ABIE/ BBIE/ ASBIE	Dictionary Entry Name	Short Name	Definition	TDED	Qualified Data Type UID	Occurrence MIN	Occurrence Max
ABIE	Supply Chain_ Trade Transaction. Details	Supply Chain Trade Transaction	A group of supply chain trade line items, trade agreement, trade delivery and trade settlement details.			#N/B	#N/B
ASBIE	Supply Chain_ Trade Transaction. Included. Supply Chain_ Trade Line Item	Included Trade Line Item	A trade line item included in this supply chain trade transaction.			1	unbounded
ASBIE	Supply Chain_ Trade Transaction. Applicable. Header_ Trade Agreement	Header Trade Agreement	A trade agreement header applicable to this supply chain trade transaction, such as payment or delivery terms.			1	1
ASBIE	Supply Chain_ Trade Transaction. Applicable. Header_ Trade Delivery	Header Trade Delivery	A trade delivery header applicable to this supply chain trade transaction.			1	1
ASBIE	Supply Chain_ Trade Transaction. Applicable. Header_ Trade Settlement	Header Trade Settlement	The trade settlement header applicable to this supply chain trade transaction.			1	1
ABIE	Tax_ Registration. Details	Tax Registration	Registration with a specific tax authority.			#N/B	#N/B
BBIE	Tax_ Registration. Identification. Identifier	ID	The unique identifier for this tax registration.			0	1
ASBIE	Tax_ Registration. Associated. Registered_ Tax	Registered Tax	The registered tax associated with this tax registration.			0	1
ABIE	Trade Settlement Header_ Monetary Summation. Details	Trade Settlement Header Monetary Summation	A collection of monetary amount totals, specified at header level, for a trade settlement.			#N/B	#N/B
BBIE	Trade Settlement Header_ Monetary Summation. Line Total. Amount	Line Total Amount	A monetary value of the line amount total being reported in this trade settlement header monetary summation.			0	unbounded
BBIE	Trade Settlement Header_ Monetary Summation. Charge Total. Amount	Charge Total Amount	A monetary value of the total of all charge amounts being reported in this trade settlement header monetary summation.			0	unbounded

ABIE/ BBIE/ ASBIE	Dictionary Entry Name	Short Name	Definition	TDED	Qualified Data Type UID	Occurrence MIN	Occurrence Max
BBIE	Trade Settlement Header_ Monetary Summation. Allowance Total. Amount	Allowance Total Amount	A monetary value of the total of all allowance amounts being reported in this trade settlement header monetary summation.			0	unbounded
BBIE	Trade Settlement Header_ Monetary Summation. Tax Basis Total. Amount	Tax Basis Total Amount	A monetary value of the total of all tax basis amounts being reported in this trade settlement monetary summation.			0	unbounded
BBIE	Trade Settlement Header_ Monetary Summation. Tax Total. Amount	Tax Total Amount	A monetary value of the total of all tax amounts being reported in this trade settlement header monetary summation.			0	unbounded
BBIE	Trade Settlement Header_ Monetary Summation. Rounding. Amount	Rounding Amount	A monetary value of a rounding amount being applied in this trade settlement header monetary summation.			0	unbounded
BBIE	Trade Settlement Header_ Monetary Summation. Grand Total. Amount	Grand Total Amount	A monetary value of the grand total of this trade settlement header monetary summation, to include addition and subtraction of individual summation amounts.			0	unbounded
ABIE	Trade Settlement Line_ Monetary Summation. Details	Trade Settlement Line Monetary Summation	A collection of monetary amount totals, specified at line level, for a trade settlement.			#N/B	#N/B
BBIE	Trade Settlement Line_ Monetary Summation. Line Total. Amount	Line Total Amount	A monetary value of the line amount total being reported in this trade settlement line monetary summation.			0	unbounded
BBIE	Trade Settlement Line_ Monetary Summation. Charge Total. Amount	Charge Total Amount	A monetary value of the total of all charge amounts being reported in this trade settlement line monetary summation.			0	unbounded
BBIE	Trade Settlement Line_ Monetary Summation. Allowance Total. Amount	Allowance Total Amount	A monetary value of the total of all allowance amounts being reported in this trade settlement line monetary summation.			0	unbounded

ABIE/ BBIE/ ASBIE	Dictionary Entry Name	Short Name	Definition	TDED	Qualified Data Type UID	Occurrence MIN	Occurrence Max
BBIE	Trade Settlement Line_ Monetary Summation. Tax Basis Total. Amount	Tax Basis Total Amount	A monetary value of the total of all tax basis amounts being reported in this trade settlement line monetary summation.			0	unbounded
BBIE	Trade Settlement Line_ Monetary Summation. Tax Total. Amount	Tax Total Amount	A monetary value of the total of all tax amounts being reported in this trade settlement line monetary summation.			0	unbounded
BBIE	Trade Settlement Line_ Monetary Summation. Grand Total. Amount	Grand Total Amount	A monetary value of the grand total of this trade settlement line monetary summation, to include addition and subtraction of individual summation amounts.			0	unbounded
ABIE	Trade Settlement_ Financial Card. Details	Trade Settlement Financial Card	A card used to represent a financial account for a trade settlement.			#N/B	#N/B
BBIE	Trade Settlement_ Financial Card. Microchip. Indicator	Microchip Indicator	The indication of whether or not this trade settlement financial card has a microchip.			0	1
BBIE	Trade Settlement_ Financial Card. Identification. Identifier	ID	The unique identifier, commonly known as the card number, of this trade settlement financial card.			0	1
BBIE	Trade Settlement_ Financial Card. Type. Code	Type Code	The code specifying the type of this trade settlement financial card, such as debit or credit.			0	1
BBIE	Trade Settlement_ Financial Card. Cardholder Name. Text	Cardholder Name	The cardholder name as it appears on this trade settlement financial card. This may include both an individual authorized to use the card as well as the organization that owns the card.			0	1
BBIE	Trade Settlement_ Financial Card. Expiry. Date	Expiry Date	The date of expiry up to which this trade settlement financial card is valid.			0	1

ABIE/ BBIE/ ASBIE	Dictionary Entry Name	Short Name	Definition	TDED	Qualified Data Type UID	Occurrence MIN	Occurrence Max
BBIE	Trade Settlement_ Financial Card. Verification. Numeric	Verification Number	The unique card verification number for security purposes to help verify the card user is in actual possession of this trade settlement financial card.			0	1
BBIE	Trade Settlement_ Financial Card. Valid From. Date Time	Valid From Date	The date from which this trade settlement financial card is valid.			0	1
BBIE	Trade Settlement_ Financial Card. Credit Limit. Amount	Credit Limit Amount	A monetary value of the credit limit for this trade settlement financial card.			0	unbounded
BBIE	Trade Settlement_ Financial Card. Credit Available. Amount	Credit Available Amount	A monetary value of the credit available for this trade settlement financial card.			0	unbounded
BBIE	Trade Settlement_ Financial Card. Interest Rate. Percent	Interest Rate	The interest rate expressed as a percentage for this trade settlement financial card.			0	1
BBIE	Trade Settlement_ Financial Card. Issuing Company Name. Text	Issuing Company Name	The issuing company name, expressed as text, for this trade settlement financial card.			0	1
BBIE	Trade Settlement_ Financial Card. Description. Text	Description	The textual description of this trade settlement financial card.			0	1
ABIE	Trade Settlement_ Payment Means. Details	Trade Settlement Payment Means	The means by which a payment will be or has been made for trade settlement purposes.			#N/B	#N/B
BBIE	Trade Settlement_ Payment Means. Payment Channel. Code	Payment Channel Code	The code specifying the payment channel through which this trade settlement payment is to be processed (Reference United Nations Code List (UNCL) 4435).	(4435)	UN02000081	0	1
BBIE	Trade Settlement_ Payment Means. Type. Code	Type Code	The code specifying the type of trade settlement payment means, such as cash or check.	(4461)	UN02000010	0	1
BBIE	Trade Settlement_ Payment Means. Guarantee Method. Code	Guarantee Method Code	The code specifying the method of guarantee for this trade settlement payment means.	(4431)	UN02000009	0	1

ABIE/ BBIE/ ASBIE	Dictionary Entry Name	Short Name	Definition	TDED	Qualified Data Type UID	Occurrence MIN	Occurrence Max
BBIE	Trade Settlement_ Payment Means. Payment Method. Code	Payment Method Code	The code specifying the method by which a payment may be made for this trade settlement payment means.			0	1
BBIE	Trade Settlement_ Payment Means. Information. Text	Information	Information, expressed as text, for this trade settlement payment means.			0	unbounded
BBIE	Trade Settlement_ Payment Means. Identification. Identifier	ID	An identifier for this trade settlement payment means.	(4461)		0	unbounded
ASBIE	Trade Settlement_ Payment Means. Applicable. Trade Settlement_ Financial Card	Financial Card	A financial card applicable to this trade settlement payment means.			0	1
ASBIE	Trade Settlement_ Payment Means. Payer_ Party. Debtor_ Financial Account	Payer Debtor Financial Account	The debtor financial account of the payer party for this trade settlement payment means.			0	1
ASBIE	Trade Settlement_ Payment Means. Payee_ Party. Creditor_ Financial Account	Payee Creditor Financial Account	The creditor financial account of the payee party for this trade settlement payment means.			0	1
ASBIE	Trade Settlement_ Payment Means. Payer_ Specified. Debtor_ Financial Institution	Payer Debtor Financial Institution	The debtor financial institution of the payer party specified for this trade settlement payment means.			0	1
ASBIE	Trade Settlement_ Payment Means. Payee_ Specified. Creditor_ Financial Institution	Payee Creditor Financial Institution	The creditor financial institution of the payee party specified for this trade settlement payment means.			0	1
ABIE	Trade_ Accounting Account. Details	Trade Accounting Account	A specific trade account for recording debits and credits to general accounting, cost accounting or budget accounting.			#N/B	#N/B
BBIE	Trade_ Accounting Account. Identification. Identifier	ID	The unique identifier for this trade accounting account.			1	1
BBIE	Trade_ Accounting Account. Set Trigger. Code	Set Trigger Code	A code specifying a set trigger for this trade accounting account to be used in response to a specific event or a set of events.	(1001)	UN02000110	0	1

ABIE/ BBIE/ ASBIE	Dictionary Entry Name	Short Name	Definition	TDED	Qualified Data Type UID	Occurrence MIN	Occurrence Max
BBIE	Trade_Accounting Account. Type. Code	Type Code	The code specifying the type of trade accounting account, such as general (main), secondary, cost accounting or budget account.		UN02000101	0	1
BBIE	Trade_Accounting Account. Amount Type. Code	Amount Type Code	The code specifying the amount type for this trade accounting account.		UN02000102	0	1
BBIE	Trade_Accounting Account. Name. Text	Name	The name, expressed as text, of this trade accounting account.			0	1
BBIE	Trade_Accounting Account. Cost Reference Dimension Pattern. Text	Cost Reference Dimension Pattern Text	The cost reference dimension pattern, expressed as text, for this trade accounting account.			0	1
ABIE	Trade_Address. Details	Trade Address	The location at which a particular trade related organization or person may be found or reached.			#N/B	#N/B
BBIE	Trade_Address. Identification. Identifier	ID	A unique identifier for this trade address.			0	1
BBIE	Trade_Address. Postcode. Code	Postcode	A code specifying the postcode of this trade address.	(3251)		0	1
BBIE	Trade_Address. Post Office Box. Text	Post Office Box	The unique identifier, expressed as text, of a container commonly referred to as a box, in a post office or other postal service location, assigned to a person or organization, where postal items may be kept for this trade address.	(3042)		0	1
BBIE	Trade_Address. Building Name. Text	Building Name	The name, expressed as text, of a building, a house or other structure on a street at this trade address.			0	1
BBIE	Trade_Address. Line One. Text	Line One	The first free form line, expressed as text, of this trade address.	(3286)		0	1
BBIE	Trade_Address. Line Two. Text	Line Two	The second free form line, expressed as text, of this trade address.	(3286)		0	1

ABIE/ BBIE/ ASBIE	Dictionary Entry Name	Short Name	Definition	TDED	Qualified Data Type UID	Occurrence MIN	Occurrence Max
BBIE	Trade_ Address. Line Three. Text	Line Three	The third free form line, expressed as text, of this trade address.	(3286)		0	1
BBIE	Trade_ Address. Line Four. Text	Line Four	The fourth free form line, expressed as text, of this trade address.	(3286)		0	1
BBIE	Trade_ Address. Line Five. Text	Line Five	The fifth free form line, expressed as text, of this trade address.	(3286)		0	1
BBIE	Trade_ Address. Street Name. Text	Street Name	A name, expressed as text, of a street or thoroughfare for this trade address.			0	1
BBIE	Trade_ Address. City Name. Text	City Name	The name, expressed as text, of the city, town or village of this trade address.	(3164)		0	1
BBIE	Trade_ Address. City Sub-Division Name. Text	City Sub-Division Text	A name, expressed as text, of a sub-division of a city for this trade address, for example a district or borough.			0	1
BBIE	Trade_ Address. Country. Identifier	Country Code	The unique identifier of a country for this trade address.	[3207]	UN02000003	0	1
BBIE	Trade_ Address. Country Name. Text	Country Name	A name, expressed as text, of the country for this trade address.			0	unbounded
BBIE	Trade_ Address. Country Sub-Division. Identifier	Country Sub-Division Code	A unique identifier of the country sub-division for this trade address.	(3229)		0	1
BBIE	Trade_ Address. Country Sub-Division Name. Text	Country Sub-Division Name	A name, expressed as text, of the sub-division of a country for this trade address.	(3228)		0	unbounded
BBIE	Trade_ Address. Attention Of. Text	Attention Of	The name, expressed as text, of a person or department in the organization to whom incoming mail is marked with words such as 'for the attention of' or 'FAO' or 'ATTN' for this trade address.			0	1
BBIE	Trade_ Address. Care Of. Text	Care Of	The name, expressed as text, of a person or organization at this trade address to whom incoming mail is			0	1

ABIE/ BBIE/ ASBIE	Dictionary Entry Name	Short Name	Definition	TDED	Qualified Data Type UID	Occurrence MIN	Occurrence Max
			marked with words such as 'care of' or 'C/O'.				
BBIE	Trade_ Address. Building Number. Text	Building Number	The building number, expressed as text, in this trade address.			0	1
BBIE	Trade_ Address. Department Name. Text	Department Name	The name, expressed as text, of a department for this trade address.			0	1
BBIE	Trade_ Address. Additional_ Street Name. Text	Additional Street Name	The additional name of a street, expressed as text, for this trade address.			0	1
ABIE	Trade_ Allowance Charge. Details	Trade Allowance/Charge	A component of pricing, such as an allowance or charge for trade purposes.			#N/B	#N/B
BBIE	Trade_ Allowance Charge. Charge. Indicator	Charge Indicator	The indication of whether or not the trade allowance charge is a charge.			0	1
BBIE	Trade_ Allowance Charge. Identification. Identifier	ID	The unique identifier for this trade allowance charge.	(1230)		0	1
BBIE	Trade_ Allowance Charge. Sequence. Numeric	Sequence Number	The sequence number for applying this trade allowance charge.			0	1
BBIE	Trade_ Allowance Charge. Calculation. Percent	Calculation Percent	The percentage applied to calculate this trade allowance charge.			0	1
BBIE	Trade_ Allowance Charge. Basis. Amount	Basis Amount	The monetary value that is the basis on which this trade allowance charge is calculated.			0	1
BBIE	Trade_ Allowance Charge. Basis. Quantity	Basis Quantity	The quantity on which this trade allowance charge is based.			0	1
BBIE	Trade_ Allowance Charge. Prepaid. Indicator	Prepaid Indicator	The indication of whether or not this trade allowance charge is prepaid.			0	1
BBIE	Trade_ Allowance Charge. Actual. Amount	Actual Amount	An actual monetary value of the trade allowance charge.			0	unbounded

ABIE/ BBIE/ ASBIE	Dictionary Entry Name	Short Name	Definition	TDED	Qualified Data Type UID	Occurrence MIN	Occurrence Max
BBIE	Trade_ Allowance Charge. Unit_ Basis. Amount	Unit Basis Amount	The monetary value of the unit basis on which the allowance or charge is calculated.			0	1
BBIE	Trade_ Allowance Charge. Reason. Code	Reason Code	The code specifying the reason for this trade allowance charge.	(4465)	UN02000118	0	1
BBIE	Trade_ Allowance Charge. Reason. Text	Reason Text	The reason, expressed as text, for this trade allowance charge.			0	1
BBIE	Trade_ Allowance Charge. Type. Code	Type Code	The code specifying the type of this trade allowance charge.	(5189)	UN02000134	0	1
ASBIE	Trade_ Allowance Charge. Category. Trade_ Tax	Tax Category	A tax category of this trade allowance charge.			0	unbounded
ASBIE	Trade_ Allowance Charge. Actual. Trade_ Currency Exchange	Actual Currency Exchange	The actual trade currency exchange for this trade allowance charge.			0	1
ABIE	Trade_ Contact. Details	Trade Contact	A person or a department that acts as a point of contact with another person or department in a trading relationship.			#N/B	#N/B
BBIE	Trade_ Contact. Identification. Identifier	ID	The unique identifier for this trade contact.	(3413)		0	1
BBIE	Trade_ Contact. Person Name. Text	Person Name	The name, expressed as text, of this trade contact person.	(3412)		0	1
BBIE	Trade_ Contact. Department Name. Text	Department Name	The name, expressed as text, of the department to which this trade contact belongs within an organization.	(3412)		0	1
BBIE	Trade_ Contact. Type. Code	Type Code	The code specifying the type of trade contact.	(3139)	UN02000122	0	1
BBIE	Trade_ Contact. Job Title. Text	Job Title	The job title, position or designation, expressed as text, of this trade contact within an organization, such as Director, Software Engineer, Purchasing Manager.			0	1
BBIE	Trade_ Contact. Responsibility. Text	Responsibility Text	A responsibility, expressed as text, of this trade contact.			0	1

ABIE/ BBIE/ ASBIE	Dictionary Entry Name	Short Name	Definition	TDED	Qualified Data Type UID	Occurrence MIN	Occurrence Max
BBIE	Trade_Contact. Person_ Identification. Identifier	Person ID	A unique identifier for this trade contact person.	(3413)		0	unbounded
ASBIE	Trade_Contact. Telephone. Universal_ Communication	Telephone	Telephone communication information for this trade contact.			0	1
ASBIE	Trade_Contact. Direct_ Telephone. Universal_ Communication	Direct Telephone	The direct telephone communication information for this trade contact.			0	1
ASBIE	Trade_Contact. Mobile_ Telephone. Universal_ Communication	Mobile Telephone	The mobile telephone communication information for this trade contact.			0	1
ASBIE	Trade_Contact. Fax. Universal_ Communication	Fax	Fax communication information for this trade contact.			0	1
ASBIE	Trade_Contact. Email_ URI. Universal_ Communication	Email Address	The email URI communication information for this trade contact.			0	1
ASBIE	Trade_Contact. Telex. Universal_ Communication	Telex	Telegraphy (Telex) communication information for this trade contact.			0	1
ASBIE	Trade_Contact. VOIP. Universal_ Communication	VOIP	Voice Over Internet Protocol (VOIP) communication information for this trade contact.			0	1
ASBIE	Trade_Contact. Instant Messaging. Universal_ Communication	Instant Messaging	Instant messaging communication information for this trade contact.			0	1
ASBIE	Trade_Contact. Specified. Note	Note	A note specified for this trade contact.			0	unbounded
ASBIE	Trade_Contact. Specified. Contact_ Person	Person	The contact person specified for this trade contact.			0	1
ABIE	Trade_ Country Sub-Division. Details	Trade Country Sub-Division	A political or physical area or region within the political boundaries of a country used or referenced for trade purposes.			#N/B	#N/B
BBIE	Trade_ Country Sub-Division. Identification. Identifier	ID	The unique identifier for this trade country sub-division.	(3229)		0	1
BBIE	Trade_ Country Sub-Division. Name. Text	Name	A name, expressed as text, of this trade country sub-division.	(3228)		0	unbounded

ABIE/ BBIE/ ASBIE	Dictionary Entry Name	Short Name	Definition	TDED	Qualified Data Type UID	Occurrence MIN	Occurrence Max
ABIE	Trade_Country. Details	Trade Country	The area of land that belongs to a nation together with its properties, such as population, political organization, etc., used or referenced for trade purposes.			#N/B	#N/B
BBIE	Trade_Country. Identification. Identifier	Code	A unique identifier for this trade country.	[3207]	UN02000003	0	1
BBIE	Trade_Country. Name. Text	Name	A name, expressed as text, of this trade country.	(3206)		0	unbounded
ASBIE	Trade_Country. Subordinate. Trade_Country Sub-Division	Sub-Division	A trade country sub-division that is subordinate to this trade country, such as a state, a county, a canton, a province.			0	unbounded
ABIE	Trade_Currency Exchange. Details	Trade Currency Exchange	The conversion of one currency to another for trade purposes.			#N/B	#N/B
BBIE	Trade_Currency Exchange. Source Currency. Code	Source Currency Code	The code specifying the source currency of a trade related currency conversion.	[6345]	UN02000004	1	1
BBIE	Trade_Currency Exchange. Source Unit Basis. Numeric	Source Unit Basis	The numeric unit basis of the source currency used in this trade related currency exchange rate calculation.			0	1
BBIE	Trade_Currency Exchange. Target Currency. Code	Target Currency Code	The code specifying the target currency of a trade related currency conversion.	[6345]	UN02000004	1	1
BBIE	Trade_Currency Exchange. Target Unit Base. Numeric	Target Unit Basis	The numeric unit basis of the target currency used in this trade related currency exchange rate calculation.			0	1
BBIE	Trade_Currency Exchange. Market. Identifier	Market ID	The unique identifier of the currency exchange market from which the exchange rate is taken for trade purposes.	(6341)		0	1
BBIE	Trade_Currency Exchange. Conversion. Rate	Conversion Rate	The rate factor used for conversion from the source currency to the target currency for trade purposes.	(5402)		1	1

ABIE/ BBIE/ ASBIE	Dictionary Entry Name	Short Name	Definition	TDED	Qualified Data Type UID	Occurrence MIN	Occurrence Max
BBIE	Trade_Currency Exchange. Conversion Rate. Date Time	Conversion Rate Date Time	The date, time, date time or other date time value of the conversion rate for this trade related currency exchange.			0	1
ASBIE	Trade_Currency Exchange. Associated. Referenced_Document	Associated Document	An associated document referenced for this trade related currency exchange.			0	1
ABIE	Trade_Delivery Terms. Details	Trade Delivery Terms	Conditions agreed upon between the parties with regard to the delivery of goods and or services for trade purposes.			#N/B	#N/B
BBIE	Trade_Delivery Terms. Delivery Type. Code	Code	The code specifying the type of delivery for these trade delivery terms.	(4053)	UN02000005	0	1
BBIE	Trade_Delivery Terms. Description. Text	Description	A textual description of these trade delivery terms.	(4052)		0	unbounded
ASBIE	Trade_Delivery Terms. Relevant. Trade_Location	Relevant Location	The trade location relevant for these trade delivery terms.			0	1
ABIE	Trade_Location. Details	Trade Location	A physical location or place used or referenced for trade purposes.			#N/B	#N/B
BBIE	Trade_Location. Country. Identifier	Country Code	The unique identifier of a country location used or referenced in trade.	[3207]	UN02000003	0	1
BBIE	Trade_Location. Country Name. Text	Country Name	The name, expressed as text, of a country location used or referenced in trade.			0	1
BBIE	Trade_Location. Identification. Identifier	ID	The unique identifier for this location used or referenced in trade.	(3225)		0	1
BBIE	Trade_Location. Name. Text	Name	The name, expressed as text, of this location used or referenced in trade.	(3224)		0	1
ABIE	Trade_Party. Details	Trade Party	An individual, a group, or a body having a role in a trade business function.			#N/B	#N/B
BBIE	Trade_Party. Identification. Identifier	ID	A unique identifier of this trade party.	(3039)		0	unbounded
BBIE	Trade_Party. Global_ Identification. Identifier	Global ID	A globally unique identifier of this trade party.	(3039)		0	unbounded

ABIE/ BBIE/ ASBIE	Dictionary Entry Name	Short Name	Definition	TDED	Qualified Data Type UID	Occurrence MIN	Occurrence Max
BBIE	Trade_Party. Name. Text	Name	The name, expressed as text, for this trade party.	(3036)		0	1
BBIE	Trade_Party. Role. Code	Role Code	A code specifying the role of this trade party.	(3035)	UN02000044	0	unbounded
BBIE	Trade_Party. Description. Text	Description	A textual description of this trade party.			0	unbounded
ASBIE	Trade_Party. Specified. Legal_Organization	Legal Organization	The legally constituted organization specified for this trade party.			0	1
ASBIE	Trade_Party. Defined. Trade_Contact	Defined Contact Details	A trade contact defined for this trade party.			0	unbounded
ASBIE	Trade_Party. Postal. Trade_Address	Postal Address	The postal address for this trade party.			0	1
ASBIE	Trade_Party. URI. Universal_Communication	URI	A Uniform Resource Identifier (URI) communication for this trade party, such as a web or email address.			0	unbounded
ASBIE	Trade_Party. Specified. Tax_Registration	Tax Registration	A tax registration specified for this trade party.			0	unbounded
ASBIE	Trade_Party. End Point_ URI. Universal_Communication	End Point URI	The communication address of the end point URI for this trade party.			0	1
ASBIE	Trade_Party. Logo_ Associated. Specified_ Binary File	Logo Binary File	A file containing a specified binary representation of a logo associated with this trade party.			0	unbounded
ABIE	Trade_Payment Discount Terms. Details	Trade Payment Discount Terms	Trade terms and conditions by which a discount is or can be applied to a payable amount.			#N/B	#N/B
BBIE	Trade_Payment Discount Terms. Basis. Date Time	Basis Date Time	The date, time, date time, or other date time value used as the basis to calculate the discount in the trade payment discount terms.			0	1
BBIE	Trade_Payment Discount Terms. Basis Period. Measure	Basis Period Measure	The measure of the basis period for these trade payment discount terms.			0	1

ABIE/ BBIE/ ASBIE	Dictionary Entry Name	Short Name	Definition	TDED	Qualified Data Type UID	Occurrence MIN	Occurrence Max
BBIE	Trade_ Payment Discount Terms. Basis. Amount	Basis Amount	A monetary value used as a basis to calculate the discount in these trade payment discount terms.			0	1
BBIE	Trade_ Payment Discount Terms. Calculation. Percent	Calculation Percent	The percent used to calculate the discount in these trade payment discount terms.	(5056)		0	1
BBIE	Trade_ Payment Discount Terms. Actual Discount. Amount	Actual Discount Amount	A monetary value of the actual discount in these trade payment discount terms.			0	1
ABIE	Trade_ Payment Penalty Terms. Details	Trade Payment Penalty Terms	Trade terms and conditions by which a penalty is or can be applied to a payable amount.			#N/B	#N/B
BBIE	Trade_ Payment Penalty Terms. Basis. Date Time	Basis Date Time	The date, time, date time, or other date time value used as the basis to calculate these trade payment penalty terms.			0	1
BBIE	Trade_ Payment Penalty Terms. Basis Period. Measure	Basis Period Measure	The measure of the period used as a basis to calculate these trade payment penalty terms.			0	1
BBIE	Trade_ Payment Penalty Terms. Basis. Amount	Basis Amount	A monetary value used as a basis to calculate these trade payment penalty terms.			0	1
BBIE	Trade_ Payment Penalty Terms. Calculation. Percent	Calculation Percent	The percent applied to calculate these trade payment penalty terms.			0	1
BBIE	Trade_ Payment Penalty Terms. Actual Penalty. Amount	Actual Penalty Amount	A monetary value of the actual penalty in these trade payment penalty terms.			0	1
ABIE	Trade_ Payment Terms. Details	Trade Payment Terms	Terms and conditions by which payment has been or will be made for trade purposes.			#N/B	#N/B
BBIE	Trade_ Payment Terms. Identification. Identifier	ID	The unique identifier of these trade payment terms.	(4277)	UN02000012	0	1
BBIE	Trade_ Payment Terms. From Event. Code	From Event Code	The code specifying the event from which these trade payment terms are offered for a length of time.	(2475)	UN02000008	0	1

ABIE/ BBIE/ ASBIE	Dictionary Entry Name	Short Name	Definition	TDED	Qualified Data Type UID	Occurrence MIN	Occurrence Max
BBIE	Trade_ Payment Terms. Settlement Period. Measure	Settlement Period Measure	The measure of the number of settlement periods from this trade payment term time reference to the latest payment date, such as 30 days, 3 months.			0	1
BBIE	Trade_ Payment Terms. Description. Text	Description	A textual description of these trade payment terms.	(4276)		0	unbounded
BBIE	Trade_ Payment Terms. Due Date. Date Time	Deprecated Due Date Date Time	The date, time, date time, or other date time value for a due date specified by these trade payment terms.			0	1
BBIE	Trade_ Payment Terms. Type. Code	Type Code	A code specifying the type of trade payment terms.	(4279)	UN02000083	0	1
BBIE	Trade_ Payment Terms. Instruction_ Type. Code	Instruction Type Code	A code specifying a type of instruction for these trade payment terms.	(4279)		0	1
BBIE	Trade_ Payment Terms. Direct Debit Mandate_ Identification. Identifier	Direct Debit Mandate ID	An identifier of a direct debit mandate in these trade payment terms.	(4277)		0	unbounded
BBIE	Trade_ Payment Terms. Partial Payment. Percent	Partial Payment Percent	A partial payment, expressed as a percent, in these trade payment terms.			0	1
BBIE	Trade_ Payment Terms. Payment Means_ Identification. Identifier	Payment Means ID	An identifier of a payment means in these trade payment terms.	(4277)		0	unbounded
BBIE	Trade_ Payment Terms. Partial Payment. Amount	Partial Payment Amount	A monetary value of a partial payment in these trade payment terms.			0	unbounded
ASBIE	Trade_ Payment Terms. Applicable. Trade_ Payment Penalty Terms	Payment Penalty Terms	Trade payment penalty terms applicable to these trade payment terms.			0	1
ASBIE	Trade_ Payment Terms. Applicable. Trade_ Payment Discount Terms	Payment Discount Terms	Trade payment discount terms applicable to these trade payment terms.			0	1
ASBIE	Trade_ Payment Terms. Payee. Trade_ Party	Payee	A payee party in these trade payment terms.			0	unbounded
ABIE	Trade_ Price. Details	Trade Price	A sum of money for which something is or may be bought or sold for trade purposes.			#N/B	#N/B

ABIE/ BBIE/ ASBIE	Dictionary Entry Name	Short Name	Definition	TDED	Qualified Data Type UID	Occurrence MIN	Occurrence Max
BBIE	Trade_ Price. Type. Code	Type Code	The code specifying the type of trade price.	(5375)	UN02000013	0	1
BBIE	Trade_ Price. Charge. Amount	Charge Amount	A monetary value of the trade price charge.			1	unbounded
BBIE	Trade_ Price. Basis. Quantity	Basis Quantity	The quantity on which the trade price is based.	(5310)		0	1
BBIE	Trade_ Price. Minimum. Quantity	Minimum Quantity	The minimum quantity in a range for which this trade price applies.			0	1
BBIE	Trade_ Price. Maximum. Quantity	Maximum Quantity	The maximum quantity in a range for which the trade price applies.			0	1
BBIE	Trade_ Price. Change Reason. Text	Change Reason Text	A reason, expressed as text, for a change of this trade price.			0	unbounded
BBIE	Trade_ Price. Order_ Unit Conversion Factor. Numeric	Order Unit Conversion Factor	The value used as the factor to convert the order unit into the price unit for this trade price.	(5394)		0	1
ASBIE	Trade_ Price. Applied. Trade_ Allowance Charge	Applied Allowance/Charge	An allowance or charge applied to the trade price.			0	unbounded
ASBIE	Trade_ Price. Validity. Specified_ Period	Validity Period	A specified period for which this trade price is valid.			0	1
ASBIE	Trade_ Price. Delivery. Trade_ Location	Delivery Location	A delivery location for this trade price.			0	unbounded
ASBIE	Trade_ Price. Trade_ Comparison. Reference_ Price	Trade Comparison Price	A price that provides a trade comparison with this trade price.			0	unbounded
ASBIE	Trade_ Price. Associated. Referenced_ Document	Associated Document	An associated document referenced for this trade price.			0	unbounded
ABIE	Trade_ Product Instance. Details	Trade Product Instance	An individual trade product or batch of similar trade products produced by human or mechanical effort or by a natural process.			#N/B	#N/B
BBIE	Trade_ Product Instance. Global Serial_ Identification. Identifier	Global Serial ID	The unique global serial identifier for this trade product instance.			0	1

ABIE/ BBIE/ ASBIE	Dictionary Entry Name	Short Name	Definition	TDED	Qualified Data Type UID	Occurrence MIN	Occurrence Max
BBIE	Trade_ Product Instance. Batch_ Identification. Identifier	Batch ID	The unique batch identifier for this trade product instance.			0	1
BBIE	Trade_ Product Instance. Kanban_ Identification. Identifier	Kanban ID	The unique kanban identifier for this trade product instance.			0	1
BBIE	Trade_ Product Instance. Supplier Assigned Serial_ Identification. Identifier	Supplier Assigned Serial ID	The unique supplier assigned serial identifier for this trade product instance.			0	1
BBIE	Trade_ Product Instance. Best Before. Date Time	Best Before Date Time	The date, time, date time, or other date time value before which it is best to consume the items contained in this trade product instance.	(2497)		0	1
BBIE	Trade_ Product Instance. Expiry. Date Time	Expiry Date Time	The date, time, date time, or other date time value of expiry of the items contained in the trade product instance.			0	1
BBIE	Trade_ Product Instance. Sell By. Date Time	Sell By Date Time	The date, time, date time, or other date time value by after which the items contained in the trade product instance should not be sold.			0	1
BBIE	Trade_ Product Instance. Serial_ Identification. Identifier	Serial ID	A unique serial identifier for this trade product instance.			0	unbounded
BBIE	Trade_ Product Instance. Registration_ Identification. Identifier	Registration ID	A unique registration identifier, such as a vehicle licence plate identification, for this trade product instance.			0	unbounded
ASBIE	Trade_ Product Instance. Production. Supply Chain_ Event	Production Event	The production event for this trade product instance.			0	1
ASBIE	Trade_ Product Instance. Packaging. Supply Chain_ Event	Packaging Event	The packaging event for this trade product instance.			0	1
ASBIE	Trade_ Product Instance. Applicable. Material_ Goods Characteristic	Material Goods Characteristic	A distinguishing material feature applicable to this trade product instance.			0	unbounded
ASBIE	Trade_ Product Instance. Applicable. Product_ Characteristic	Product Characteristic	A product characteristic applicable to this trade product instance.			0	unbounded

ABIE/ BBIE/ ASBIE	Dictionary Entry Name	Short Name	Definition	TDED	Qualified Data Type UID	Occurrence MIN	Occurrence Max
ABIE	Trade_Product. Details	Trade Product	Any tangible output or service produced by human or mechanical effort or by a natural process for trade purposes.			#N/B	#N/B
BBIE	Trade_Product. Identification. Identifier	ID	A unique identifier for this trade product.	(7135)		0	1
BBIE	Trade_Product. Global_ Identification. Identifier	Global ID	A unique global identifier for this trade product.	(7135)		0	1
BBIE	Trade_Product. Seller Assigned_ Identification. Identifier	Seller Assigned ID	The unique seller assigned identifier for this trade product.	(7135)		0	1
BBIE	Trade_Product. Buyer Assigned_ Identification. Identifier	Buyer Assigned ID	The unique buyer assigned identifier for this trade product.	(7135)		0	1
BBIE	Trade_Product. Manufacturer Assigned_ Identification. Identifier	Manufacturer Assigned ID	A unique manufacturer assigned identifier for this trade product.	(7135)		0	1
BBIE	Trade_Product. Name. Text	Name	A name, expressed as text, for this trade product.	(7134)		0	unbounded
BBIE	Trade_Product. Trade_Name. Text	Trade Name	A trade name, expressed as text, for this trade product.	(7134)		0	1
BBIE	Trade_Product. Description. Text	Description	A textual description for this trade product.			0	1
BBIE	Trade_Product. Type. Code	Type Code	A code specifying the type of trade product.			0	1
BBIE	Trade_Product. Net Weight. Measure	Net Weight	A measure of the net weight (mass) of this trade product.			0	1
BBIE	Trade_Product. Gross Weight. Measure	Gross Weight	A measure of the gross weight (mass) of this trade product.			0	1
BBIE	Trade_Product. Product Group. Identifier	Product Group ID	A unique identifier for a product group for this trade product.			0	unbounded
BBIE	Trade_Product. End Item_Type. Code	End Item Type Code	A code specifying a type of end item for this trade product.			0	unbounded
BBIE	Trade_Product. End Item_Name. Text	End Item Name	An end item name, expressed as text, for this trade product.	(7134)		0	unbounded

ABIE/ BBIE/ ASBIE	Dictionary Entry Name	Short Name	Definition	TDED	Qualified Data Type UID	Occurrence MIN	Occurrence Max
BBIE	Trade_Product. Area Density. Measure	Area Density Measure	The measure of the area density, such as paper density 100 gsm, of this trade product.			0	1
BBIE	Trade_Product. Use_ Description. Text	Use Description	A textual description of a use of this trade product.			0	unbounded
BBIE	Trade_Product. Brand_ Name. Text	Brand Name	The brand name, expressed as text, for this trade product.	(7134)		0	1
BBIE	Trade_Product. Sub-Brand_ Name. Text	Sub-Brand Name	The sub-brand name, expressed as text, for this trade product.	(7134)		0	1
BBIE	Trade_Product. Drained_ Net Weight. Measure	Drained Net Weight	The measure of the drained net weight (mass) of this trade product.			0	1
BBIE	Trade_Product. Variable Measure. Indicator	Variable Measure Indicator	The indication of whether or not instances of this trade product have a variable measure, such as weight, length or volume.			0	1
BBIE	Trade_Product. Colour. Code	Colour Code	The code specifying the colour for this trade product.			0	1
BBIE	Trade_Product. Colour_ Description. Text	Colour Description	A textual description of the colour of this trade product.			0	unbounded
BBIE	Trade_Product. Designation. Text	Designation Text	A designation, expressed as text, for this trade product.			0	unbounded
BBIE	Trade_Product. Formatted Latest_ Product Data Change. Date Time	Latest Product Data Change Formatted Date Time	The formatted date, time, date time, or other date time value of the latest change in the product data for this trade product.	(2379)	UN02000153	0	1
ASBIE	Trade_Product. Applicable. Product_ Characteristic	Characteristic	A characteristic applicable to this trade product.			0	unbounded
ASBIE	Trade_Product. Applicable. Material_ Goods Characteristic	Material Goods Characteristic	A material goods characteristic applicable to this trade product.			0	unbounded
ASBIE	Trade_Product. Designated. Product_ Classification	Classification	A product classification designated for this trade product.			0	unbounded

ABIE/ BBIE/ ASBIE	Dictionary Entry Name	Short Name	Definition	TDED	Qualified Data Type UID	Occurrence MIN	Occurrence Max
ASBIE	Trade_Product. Individual. Trade_Product Instance	Individual Product Instance	An individual instance of this trade product.			0	unbounded
ASBIE	Trade_Product. Certification Evidence_ Reference. Referenced_Document	Certification Evidence Document	A referenced certification evidence document for this trade product.			0	unbounded
ASBIE	Trade_Product. Inspection_ Reference. Referenced_Document	Inspection Document	A referenced inspection document for this trade product.			0	unbounded
ASBIE	Trade_Product. Origin. Trade_Country	Origin Country	A country of origin for this trade product.			0	1
ASBIE	Trade_Product. Linear. Spatial_Dimension	Dimensions	Linear spatial dimensions of this trade product.			0	1
ASBIE	Trade_Product. Minimum_ Linear. Spatial_Dimension	Minimum Dimensions	Minimum linear spatial dimensions of this trade product.			0	1
ASBIE	Trade_Product. Maximum_ Linear. Spatial_Dimension	Maximum Dimensions	Maximum linear spatial dimensions of this trade product.			0	1
ASBIE	Trade_Product. Manufacturer. Trade_Party	Manufacturer	A manufacturer party for this trade product.			0	1
ASBIE	Trade_Product. Presentation. Specified_Binary File	Presentation Binary File	A binary file presentation specified for this trade product.			0	unbounded
ASBIE	Trade_Product. MSDS_ Reference. Referenced_Document	MSDS Document	A Material Safety Data Sheet (MSDS) document referenced for this product.			0	1
ASBIE	Trade_Product. Additional_ Reference. Referenced_Document	Additional Document	An additional referenced document for this trade product, such as a manual or a certificate.			0	unbounded
ASBIE	Trade_Product. Legal Rights Owner. Trade_Party	Legal Rights Owner	The party that owns the legal rights for this trade product.			0	1
ASBIE	Trade_Product. Brand Owner. Trade_Party	Brand Owner	The party that owns the brand of this trade product.			0	1
ASBIE	Trade_Product. Information. Note	Information Note	An information note for this trade product.			0	unbounded
ABIE	Trade_Tax. Details	Trade Tax	A trade related fiscal levy or duty.			#N/B	#N/B

ABIE/ BBIE/ ASBIE	Dictionary Entry Name	Short Name	Definition	TDED	Qualified Data Type UID	Occurrence MIN	Occurrence Max
BBIE	Trade_Tax. Calculated. Amount	Calculated Amount	A monetary value resulting from the calculation of this trade related tax, levy or duty.			0	unbounded
BBIE	Trade_Tax. Type. Code	Type Code	The code specifying the type of trade related tax, levy or duty, such as a code for a Value Added Tax (VAT) [Reference United Nations Code List (UNCL) 5153].	(5153)	UN02000015	0	1
BBIE	Trade_Tax. Exemption Reason. Text	Exemption Reason Text	The reason, expressed as text, for exemption from this trade related tax, levy or duty.			0	1
BBIE	Trade_Tax. Calculated. Rate	Calculated Rate	The rate used to calculate the amount of this trade related tax, levy or duty.			0	1
BBIE	Trade_Tax. Calculation Sequence. Numeric	Calculation Sequence Number	A numeric expression of the sequence in which this trade related tax is to be or has been applied when multiple taxes are applicable per calculation, such as first "Value Added Tax (VAT)", second "Transfer".			0	1
BBIE	Trade_Tax. Basis. Quantity	Basis Quantity	The quantity used as the basis for calculating the amount of this trade related tax, levy or duty.			0	1
BBIE	Trade_Tax. Basis. Amount	Basis Amount	A monetary value used as the basis on which this trade related tax, levy or duty is calculated.			0	unbounded
BBIE	Trade_Tax. Unit_Basis. Amount	Unit Basis Amount	A monetary value that constitutes the per unit basis on which this trade related tax, levy or duty is calculated.			0	unbounded
BBIE	Trade_Tax. Category. Code	Category Code	The code specifying the category to which this trade related tax, levy or duty applies, such as codes for "Exempt from Tax", "Standard Rate", "Free Export Item - Tax Not Charged"	(5305)	UN02000014	0	1

ABIE/ BBIE/ ASBIE	Dictionary Entry Name	Short Name	Definition	TDED	Qualified Data Type UID	Occurrence MIN	Occurrence Max
			[Reference United Nations Code List (UNCL) 5305].				
BBIE	Trade_ Tax. Currency. Code	Currency Code	The code specifying the currency for this trade related tax, levy or duty [UNCL 6345].	[6345]	UN02000004	0	1
BBIE	Trade_ Tax. Jurisdiction. Text	Jurisdiction Text	A jurisdiction, expressed as text, to which this trade related tax, levy or duty applies.			0	unbounded
BBIE	Trade_ Tax. Customs Duty. Indicator	Customs Duty Indicator	The indication of whether or not this trade related tax, levy or duty is a customs duty.			0	1
BBIE	Trade_ Tax. Exemption Reason. Code	Exemption Reason Code	A code specifying a reason for exemption from this trade related tax, levy or duty.			0	1
BBIE	Trade_ Tax. Tax Basis Allowance. Rate	Basis Allowance Rate	The rate of the tax basis allowance (deduction or discount) used to calculate the trade related tax, levy or duty.			0	1
BBIE	Trade_ Tax. Tax Point. Date	Tax Point Date	The date of the tax point when this trade related tax, levy or duty becomes applicable.			0	1
BBIE	Trade_ Tax. Type. Text	Type Text	The type, expressed as text, of this trade related tax, levy or duty.	(5152)		0	1
BBIE	Trade_ Tax. Information. Amount	Information Amount	A monetary value of an amount being reported for information for this trade related tax, levy or duty.			0	unbounded
BBIE	Trade_ Tax. Category Name. Text	Category Name	A category name, expressed as text, of this trade related tax, levy or duty.			0	unbounded

ABIE/ BBIE/ ASBIE	Dictionary Entry Name	Short Name	Definition	TDED	Qualified Data Type UID	Occurrence MIN	Occurrence Max
BBIE	Trade_Tax. Due Date Type. Code	Due Date Type Code	The code specifying a type of due date for this trade tax.	(5307)	UN02000016	0	1
BBIE	Trade_Tax. Rate_ Applicable. Percent	Applicable Rate Percent	The applicable rate, expressed as a percentage, for this trade tax, levy or duty.	(5510)		0	1
ASBIE	Trade_Tax. Specified. Trade_ Accounting Account	Trade Accounting Account	A specified accounting account for this trade related tax, levy or duty.			0	unbounded
ASBIE	Trade_Tax. Service Supply. Trade_ Country	Service Supply Country	The country or country sub-division where a service was supplied for this trade tax.			0	1
ASBIE	Trade_Tax. Buyer Repayable Tax_ Specified. Trade_ Accounting Account	Buyer Repayable Tax Accounting Account	The buyer repayable tax specified accounting account for this trade related tax, levy or duty.			0	1
ASBIE	Trade_Tax. Seller Payable Tax_ Specified. Trade_ Accounting Account	Seller Payable Tax Accounting Account	The seller payable tax specified accounting account for this trade related tax, levy or duty.			0	1
ASBIE	Trade_Tax. Seller Refundable Tax_ Specified. Trade_ Accounting Account	Seller Refundable Tax Accounting Account	The seller refundable tax specified accounting account for this trade related tax, levy or duty.			0	1
ASBIE	Trade_Tax. Buyer Deductible Tax_ Specified. Trade_ Accounting Account	Buyer Deductible Tax Accounting Account	The buyer deductible tax specified accounting account for this trade related tax, levy or duty.			0	1
ASBIE	Trade_Tax. Buyer Non-Deductible Tax_ Specified. Trade_ Accounting Account	Buyer Non-Deductible Tax Accounting Account	The buyer non-deductible tax specified accounting account for this trade related tax, levy or duty.			0	1
ASBIE	Trade_Tax. Place_ Applicable. Trade_ Location	Applicable Location	A location where this trade tax is applicable.			0	unbounded
ABIE	Transport_ Cargo. Details	Transport Cargo	Information about goods being transported identifying their nature for customs, statistical or transport purposes.			#N/B	#N/B

ABIE/ BBIE/ ASBIE	Dictionary Entry Name	Short Name	Definition	TDED	Qualified Data Type UID	Occurrence MIN	Occurrence Max
BBIE	Transport_ Cargo. Type. Code	Type Code	The code, such as UNECE Recommendation 21 single digit codes, specifying the type of transported cargo.		UN02000096	0	1
BBIE	Transport_ Cargo. Identification. Text	Identification Text	The identification, expressed as text, of this transport cargo that is sufficient to identify it for customs, statistical or transport purposes.	(7002)		0	1
BBIE	Transport_ Cargo. Operational Category. Code	Operational Category Code	The code specifying the operational category for this transport cargo, such as obnoxious or military.	(7085)	UN02000077	0	1
BBIE	Transport_ Cargo. Statistical Classification. Code	Statistical Classification Code	The code specifying a statistical classification for this transport cargo.	(7357)	UN02000053	0	1
ABIE	Universal_ Communication. Details	Communication	The exchange of thoughts, messages, or information, as universally exchanged by speech, signals, writing, or behaviour between persons and/or organizations.			#N/B	#N/B
BBIE	Universal_ Communication. URI. Identifier	URI	The Uniform Resource Identifier (URI), such as a web or an email address, for this universal communication.	(3148)		0	1
BBIE	Universal_ Communication. Channel. Code	Channel Code	The code specifying the channel or manner in which a universal communication can be made, such as telephone or email.	(3155)	UN02000121	0	1
BBIE	Universal_ Communication. Complete Number. Text	Complete Number	The text string of characters that make up the complete number for this universal communication.	(3148)		0	1

9 Code Lists Used

9.1 New Code List

Not applicable

9.2 Additions to an Existing Code List

Not applicable

9.3 Use or Reference of an Existing Code List

Table 8 Use or Reference of an Existing Code List

Nr	Data Element	Agency Identifier	Code List Identifier
1	AccountingAccountType	EDIFICAS-EU	UN02000101
2	AccountingAmountType	EDIFICAS-EU	UN02000102
3	AllowanceChargeIdentificationCode	UNECE	UN02000134
4	AllowanceChargeReasonCode	UNECE	UN02000118
5	CargoOperationalCategoryCode	UNECE	UN02000077
6	CargoTypeCode	UNECE	UN02000096
7	CommodityIdentificationCode	UNECE	UN02000053
8	CommunicationMeansTypeCode	UNECE	UN02000121
9	ContactFunctionCode	UNECE	UN02000122
10	DeliveryTermsCode	UNECE	UN02000005
11	DimensionTypeCode	UNECE	UN02000071
12	DocumentNameCode	UNECE	UN02000006
13	DocumentNameCode_Accounting	UNECE	UN02000110
14	DocumentStatusCode	UNECE	UN02000025
15	DutyorTaxorFeeCategoryCode	UNECE	UN02000014
16	DutyTaxFeeTypeCode	UNECE	UN02000015
17	EquipmentSizeTypeDescriptionCode	UNECE	UN02000061
18	EventTimeReferenceCode	UNECE	UN02000183
19	EventTimeReferenceCodePaymentTermsEvent	UNECE	UN02000008
20	FormattedDate Time	UNECE	UN02000153
21	GoodsTypeCode	UNECE	UN02000058
22	GoodsTypeExtensionCode	UNECE	UN02000057
23	ISO3AlphaCurrencyCode	ISO	UN02000004
24	ISOTwo-letterCountryCode	ISO	UN02000003
25	MeasurementUnitCommonCodeLinear	UNECE	UN02000092
26	MeasurementUnitCommonCodeVolume	UNECE	UN02000094
27	MeasurementUnitCommonCodeWeight	UNECE	UN02000095
28	MessageFunctionCode	UNECE	UN02000125
29	PackageTypeCode	UNECE	UN02000043
30	PackagingLevelCode	UNECE	UN02000078
31	PartyRoleCode	UNECE	UN02000044
32	PaymentGuaranteeMeansCode	UNECE	UN02000009
33	PaymentMeansChannelCode	UNECE	UN02000081
34	PaymentMeansCode	UNECE	UN02000010
35	PaymentTermsDescriptionIdentifier	UNECE	UN02000012
36	PaymentTermsTypeCode	UNECE	UN02000083

Nr	Data Element	Agency Identifier	Code List Identifier
37	PriceTypeCode	UNECE	UN02000013
38	ReferenceTypeCode	UNECE	UN02000048
39	StatusCode	UNECE	UN02000020
40	LineStatusCode	UNECE	UN02000124
41	TimeOnlyFormatCode	UNECE	UN02000016
42	TransportEquipmentCategoryCode	UNECE	UN02000087
43	TransportEquipmentFullnessCode	UNECE	UN02000088
44	TransportMeansTypeCode	UNECE	UN02000098
45	TransportModeCode	UNECE	UN02000018
46	TransportMovementStageCode	UNECE	UN02000091

9.4 Restriction of an Existing Code List

Not applicable

10 Message Library Update

10.1 Message Assembly Submission

Not applicable

10.2 Core Component Library Update

10.2.1 Referenced CCL

Not applicable

10.2.2 CCL Update Submission

Not applicable

10.3 Model Exchange File

Not applicable

10.4 Additional Information

Not applicable

Public Review

12 Definition of Terms

Term	Definition
Acceptance Of Goods	1. Date on which the goods are taken over by the carrier at the place of acceptance (CMR 4).
	2. The process of receiving a consignment usually against the issue of a receipt. As and from this moment the party accepting the consignment becomes responsible for the consignment.
Accepted	To take on a responsibility or liability for something.
Account	A formal contractual relationship established to provide for regular banking, brokerage or business services.
Accounting	Record or statement of financial transactions.
Agent	A person or company that provides a particular service, typically one organizing transactions between two other parties.
Allowance	The amount of something allowed.
Allowance Charge	Details about a component of pricing, such as a service, promotion, allowance or charge.
Amount	A number of monetary units specified in a currency where the unit of currency is explicit or implied.
Available	1. Able to be used or obtained.
	2. Goods positioning date/time, expected – Date/time on which goods are expected to be positioned.
Batch	n. A quantity or consignment of goods produced at one time. v. Arrange (things) in sets or groups.
Batch (No.)	(Identification of) a quantity or consignment of goods produced at one time.
Buyer	The party to which goods or services are sold.
Carrier	The party undertaking the transportation of goods from one point to another.
Cash	Money in the form of bills and coins.
Catalogue	A list of items arranged in a systematic order.
Category	A class or division of people or things having particular shared characteristics.
Characteristic	A feature or quality typical of a person, place, or thing.
Charge	An amount asked as a price for a service rendered or goods supplied (OED derived).
Classification	Arrangement (of a group) in classes or categories according to shared qualities or characteristics.
Commission	A sum paid to an agent in a commercial transaction.
Communication	The means of sending or receiving information, such as telephone lines or computers.
Communication (Address)	The unique identification of location, person or company within a specific means of sending or receiving information, such as telephone lines or computers.
Condition	The state of something or someone, with regard to appearance, fitness, or working order.
Conditions	1 Circumstances affecting the functioning or existence of something. 2 A state of affairs that must exist before something else is possible.
Consignee	The party by whom the goods, cargo or containers are meant to be received. The actual physical receipt can take place by another party.
Consignment	A separately identifiable collection of goods items (available to be) transported from one consignor to one consignee via one or more modes of transport as specified in one single transport document.
Consignor	The party by whom goods, cargo and containers are sent. The physical dispatch can be done by another party.
Context	The circumstances that form the setting for an event, statement, or idea, and in terms of which it can be fully understood.

Term	Definition
Contract	A legally binding agreement between two parties in which the specific titles, rights, commitments and obligations of both parties are defined.
Count	The total determined by counting.
Country Of Arrival	The country to which a means of transport is scheduled to arrive or has arrived.
Country Of Departure	The country from which a means of transport is scheduled to depart or has departed.
Country Of Destination	The country to which goods are (to be) transported.
Country Of Origin	The country in which the goods have been produced or manufactured, according to criteria laid down for the purposes of application of the Customs tariff, of quantities restrictions, or of any other measure related to trade.
Country Sub-division	A formally recognized subdivision of a country.
Creditor	One who gives credit for money or goods; one to whom a debt is owing; correlative to debtor.
Currency	That which is current as a medium of exchange; the circulating medium (whether coins or notes); the money of a country in actual use.
Currency Exchange	The conversion of financial amounts in one currency to another.
Customer	The party to which or to whom goods and/or services are supplied.
Customs	The government organization that deals with the levying of duties and taxes on imported goods from foreign countries and the control over the export and import of goods.
Date	Identification of a particular calendar day, expressed by some combination of the data elements calendar year, calendar month, calendar week, calendar day, of day of the year.
Deductible	An amount or percentage that can be taken away from or applied to another amount for purpose of reduction.
Deduction	An amount that is or may be deducted.
Deliver	Bring and handover (a letter, goods or service) to the appropriate recipient.
Delivered	The quantity provided (of something promised or expected).
Delivery	1. The action of delivering something, especially letters, goods or services. 2. The physical process of handing over goods to the consignee or to the party acting on his behalf.
Delivery Date	The date on which the delivery of goods to takes place, is scheduled to take place, or must be received.
Delivery Terms	Conditions in a sales or transportation contract that specify the carrier, routing, freight charges, place of delivery, time of delivery, etc.
Dimension	A measurable extent, such as length, breadth or height.
Disbursement	The action of dispersing money that is paid out.
Discharge	The process of unloading the goods from a means of transport.
Discount	1. A deduction from the usual cost of something. 2. (Finance) a percentage deducted from the face value of a bill of exchange or promissory note when it changes hands before the due date.
Due	Required as a legal or moral obligation. Expected at, planned for, or required by a certain time.
Duration	The time during which something continues.
Duty	A payment levied on the import, export, manufacture, or sale of goods or services.
Earliest	Not before the time or date specified.
Effective Period	The time during which something runs its course, duration; allotted time; natural lifespan.
Electronic Communication	Communications in the general sense of any communication that involves having components such as microchips and transistors that control and direct electric currents. Used to encompass, fax, telephone, e-mail, EDI, etc.
End	To come or bring to an end; finish..
Event	A significant occurrence or happening related to an object process, or person.
Exclusive	Not divided or shared with others.

Term	Definition
Expected	Regarded as likely to happen..
Expiry	The end or term of a period of time.
Family Name	A surname, the hereditary name common to all members of a family, as distinct from a forename.
Fee	A payment made to a professional person or to a professional or public body in exchange for advice or services.
Fiscal	Of or relating to government revenue, especially taxes.
Freight	Goods in transport from one location to another.
Freight Costs	Costs incurred when moving goods, by whatever means, from one place to another under the terms of a contract of carriage. In addition to transport costs, this may include such elements as packing, documentation, loading , unloading, and insurance (to the
	2. The amount of money due for the carriage of goods and payable either in advance or upon delivery.
Frequency	1) The rate at which something occurs over a period or in a given sample. 2) Occurrence many times at short intervals.
Given Name	Another term for first name, a personal name given to someone at birth or baptism and used before (or after in some national styles) a family name.
Gross	Without deduction of tax or other contributions.
	Including contents or other variable items; overall.
Gross Price	Price inclusive of all discounts, rebates, etc.; sometimes called the retail price.
IBAN	Abbreviation of International Bank Account Number.
Identification	The action or process of identifying or the fact of being identified.
Identifier	Something which identifies.
Invoice	
Invoicee	One who receives the invoice and is expected to arrange its settlement.
Invoicer	One who issues the invoice.
Issued	1) supplied or distributed for use. 2) formally sent out or made known.
Level (Packaging)	The position in a series of packaging that groups items together within a package within a package etc..
Line Item	An article or unit of any kind included in an enumeration, computation, or sum total.
Location	A particular place or position.
Logistic Service Provider	Party providing logistic services such as warehousing, re-packing products, distribution and assembly.
Lot (No.)	(Identification of) a particular group or set of people or things.
Maximum	The highest value or extreme limit.
Means (Of Payment Guarantee)	This indicates the kind of guarantee covering the payment.
Means (Of Payment)	The method used for payment.
Means (Of Settlement)	An act that discharges obligations in respect of funds or securities transfers between two or more parties.
Means (Of Transport)	The particular vehicle used for the transport of goods or persons.
Measure	A standard unit used to express size, amount, or degree.
Measurement	An amount, size, or extent as established by measuring.
Minimum	The smallest amount or quantity that is possible, usual, attainable, allowable, etc.
Monetary Adjustment	See Allowance Charge
Net	(Of an amount, value or price) remaining after deduction of tax or other contributions.

Term	Definition
Net Price	Price after all discounts, rebates, etc., have been allowed; sometimes called the wholesale price.
Net Volume	1. The amount or quantity of something free from, or not subject to, any (further) deduction. 2. (Of a weight) excluding that of packaging.
Net Weight	Measurement of quantity by means of weighing, free from, or not subject to, any (further) deduction.
Non Repudiation	Non repudiation means that the originator must digitally sign the business data and the recipient must store the business data in its original form for the mutually agreed duration.
Number	An arithmetic value, expressed by a word, symbol or figure, representing a particular amount.
Original	1. The earliest form of something. 2. Existing from the beginning: first or earliest.
Package	1. The final product of the packing operation. 2. Consisting of the packing and the contents, e.g. a box, carton, crate, barrel, pallet, etc.
Packaging	The action or process of making something into a package or enclosing a thing in packaging; the action of wrapping something up.
Payee	A person or company to whom money is being paid or is due, especially in a transaction such as the payment of a cheque or money order.
Payment	The action of paying or the process of being paid.
Payment Terms	Conditions or stipulations limiting the paying of money or its equivalent for (also of) goods, services, etc.
Payor	The person or company named as responsible for the payment of a cheque, money order, or other financial 'paper' when it is redeemed.
Percentage	1) A rate, number, or amount in each hundred. 2) Any proportion or share in relation to a whole.
Period (Of Time)	A length or portion of time. A portion of time between two time points.
Prepaid	Paid for in advance.
Pre-Payment	Payment that has taken place before the delivery.
Previous	Existing or occurring before in time or order.
Price	The amount of money (or a material equivalent) expected, required, or given in payment for a commodity or service.
Product	Any tangible output or service produced by human or mechanical effort or by a natural process.
Product Instance	An instance of an individual product or batch of similar products produced by human or mechanical effort or by a natural process.
Quantity	A certain amount or number.
Rate	Numeric information that is assigned or is determined by calculation, counting, or sequencing. It does not require a unit of quantity or unit of measure.
Rate Basis	The basis of calculation of an amount of a charge or payment expressed as an amount per some feature.
Received	Taken delivery of.
Regime	A systematic or ordered way of doing something.
Regulation	A rule prescribed for the management of some matter, or for the regulating of conduct; a governing precept or direction; a standing rule.
Remittance	A sum of money remitted.
Seller	The party selling goods or services.
Sequence	The fact of following after or succeeding; the following of one thing after another in succession; an instance of this.
Serial Number	An identification number showing the position of a manufactured item in a series.

Term	Definition
Service	Work or doing of work for another or for a community such as utilities and transport.
Service Charge	A charge made for banking or other services such as Freight Services.
Settlement	'settle' – pay (a debt or account)
Status	The position of affairs at a particular time.
Subdivision	Subdivisions of a country such as primary subdivisions, County (UK), Departement (France), State (US) etc., secondary subdivisions such.
Supplier	Someone who makes (something needed) available to someone.
Tariff	A classified list or scale of charges made in any private or public business; as, a hotel tariff, a railroad tariff.
	A tax or duty to be paid on a particular class of imports or exports.
Tax	A levy or payment for the support of a government required of persons, groups, or businesses within the domain of that government.
Terms Of Delivery	All the conditions agreed upon between a seller and a buyer with regard to the delivery of goods and/or services, e.g. CIF, FOB, or EXW from the INCOTERMS Terms of Delivery.
Terms Of Freight	All the conditions (to be) agreed upon between a transport service provider and a transport service buyer about the type of freight and charges due to carriage and whether they are prepaid or are to be collected.
Terms Of Transport	All the conditions agreed upon between a transport service provider and a transport service buyer with regard to the transportation of goods, e.g. CIF, FOB, or EXW from the INCOTERMS Terms of Delivery.
Type	A category of people or things having common characteristics.
Ultimate Consignee	A final person to whom goods are consigned.
Value	1. Material or monetary worth.
	2. The numerical amount denoted by an algebraic term; a magnitude, quantity, or number.

Disclaimer (Updated UN/CEFACT Intellectual Property Rights Policy – ECE/TRADE/C/CEFACT/2010/20/Rev.2)

ECE draws attention to the possibility that the practice or implementation of its outputs (which include but are not limited to Recommendations, norms, standards, guidelines and technical specifications) may involve the use of a claimed intellectual property right.

Each output is based on the contributions of participants in the UN/CEFACT process, who have agreed to waive enforcement of their intellectual property rights pursuant to the UN/CEFACT IPR Policy (document ECE/TRADE/C/CEFACT/2010/20/Rev.2 available at http://www.unece.org/cefact/cf_docs.html or from the ECE secretariat). ECE takes no position concerning the evidence, validity or applicability of any claimed intellectual property right or any other right that might be claimed by any third parties related to the implementation of its outputs. ECE makes no representation that it has made any investigation or effort to evaluate any such rights.

Implementers of UN/CEFACT outputs are cautioned that any third-party intellectual property rights claims related to their use of a UN/CEFACT output will be their responsibility and are urged to ensure that their use of UN/CEFACT outputs does not infringe on an intellectual property right of a third party.

ECE does not accept any liability for any possible infringement of a claimed intellectual property right or any other right that might be claimed to relate to the implementation of any of its outputs.